

# Catalogue ENG 2026

(Rev. 270426)



## OUR HISTORY

Binding Union has been designing and producing professional measuring instruments since 1975, becoming an important supplier to industries in diverse sectors such as automation, electronic, energy and marine.

In 1986 Binding Union broadened its range of products by designing a range of devices for the marine sector which, with the introduction of innovative Led lighting, later included a selection of lights with protection classes specifically for aquatic environments.

In 2010 Binding Union extended its range of lighting, creating devices capable of complying with the new safety and compliance regulations required in lifts.

The fundamental principles of the company have always been to listen to customer needs and to develop reliable solutions to their problems.

Binding Union instruments are exceptionally reliable, an important factor in this day and age and one of the reasons why it continues to supply renowned boat builders and industries in the automation, electronic and energy sectors around the world, including China.

Lifts



Marine



Automation



[www.binding.it](http://www.binding.it)



1975 - 2025





Italian Marine Industry Association



**QUALITY LED LIGHTS**  
and more...



Company



History and references

Sales Network ITALY



Products



Product catalogue and terms of sale

Sales Network ABROAD



Contacts and links

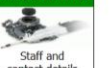

Staff and contact details

**NEW PRODUCTS - NOVITA'**

GRILLO



MICRO



BINDINO



<b>SYMBOLS</b>	<b>SYMBOLISM</b>	<b>Reading guide</b>	<b>p.</b>	<b>4</b>	
DOWNLIGHTS	<b>IRIS ANTIVANDAL</b>	surface/recess mountings UNI-EN 81-71 standards	p.	5	
	<b>IRIS, Plus, IE</b> 	underwater, with courtesy light, IP44, IP65, IP68	p.	6	
	<b>PUNTO, ZEN</b> 	Recess, indoor/outdoor	p.	7	
	<b>VIOLA, VANDA</b>	rear recessed, wall mounted, adjustable	p.	8	
	<b>SABA</b>	recess, indoor	p.	9	
	<b>MINI</b> 	recess, indoor/outdoor	p.	10	
	<b>TUBO, TUBO 340</b> 	wall, indoor	p.	11	
	<b>POLA, MIGNON</b>	wall/ceiling, outdoor, IP65	p.	12	
	COURTESY LIGHTS	<b>PERLA, GEMMA</b> 	recess, indoor/outdoor	p.	13
		<b>STELLA, SPILLO</b>	recess, indoor	p.	14
<b>GIGLIO 1 e 2</b> 		recessed, for indoor/outdoor use, IP65 and IP67	p.	15	
LAMPS	<b>AMBRA</b> 	surface, for difficult areas, IP65 and IP67	p.	16	
	<b>MATTONELLA, TECLA</b>	wall, with emergency circuit	p.	17	
	<b>MODA, SIBILLA</b>	wall, modular	p.	18	
	<b>LUXBOMA, TOUCH</b>	wall, with courtesy light and On/Off touch switch	p.	19	
	<b>ILOGO</b> 	surface, for technical rooms, with emergency	p.	20	
	<b>SELENE</b> 	wall-mounted, for technical rooms, also IP65	p.	21	
	<b>RUMBA</b> 	recess, for technical rooms, with emergency	p.	22	
	<b>SAMBA</b> 	recess, for technical rooms, with emergency	p.	23	
	<b>ATEX</b>	wall, for high-risk zones Class. 2, 22	p.	24	
	<b>FIAMMA</b>	portable, for difficult areas	p.	25	
SPOTS	<b>SPOT 25, 29</b>	wall, protection class IP67/65	p.	26	
	<b>SPOT 50, MR16</b>	recess	p.	27	
PRE-WIRED	<b>CIELO STELLATO</b>	recess, "night sky" effect, pre-wired	p.	28	
METERS	<b>PICO</b> 	panel, digital, 3 digits	p.	29	
	<b>FAST</b> 	panel, digital, 3,5 digits	p.	30	
	<b>METER</b>	panel, digital, 3,5 digits	p.	31	
	<b>MICRO</b>	panel, digital, 4,5 digits	p.	32	
	<b>MICRO 9215</b>	panel, digital, 5 digits	p.	33	
	<b>PULSAR, RPM</b>	digital, rpm, panel and portable	p.	34	
CONTROLS	<b>GRILLO</b>	navigation lights controller	p.	35	
TRASMITTERS	<b>TX73</b>	signal converter	p.	36	
SENSORS	<b>BINDINO IMQ</b>	intelligent bilge and anti-flooding switch	p.	37	
OTHER	<b>COMMANDS</b>	dimmer, luminosity changer, driver	p.	38	
	<b>COMMANDS</b>	relay control unit for controlling devices	p.	39	
	<b>COMMANDS</b>	Relay control, MODBUS RTU	p.	40	
	<b>ACCESSORIES</b>	24/12 step-down reducer, AC line protector	p.	41	
	<b>ACCESSORIES</b>	shunt and CT, current transformers	p.	42	
	<b>ACCESSORIES</b>	power supplies, battery chargers	p.	43	
	<b>ACCESSORIES</b>	for tachometers, batteries, adaptors	p.	44	
	<b>ACCESSORIES</b>	led strips, line protector, temperature probes	p.	45	
	<b>ACCESSORIES</b>	professional neon strip leds	p.	46	
	<b>ILLUMINATION</b>	main lighting techniques	p.	47	

## Reading guide

Symbol	Meaning	Symbol	Meaning
	Device with double or reinforced insulation. Do not earth.		Recessed wall or ceiling installation.
	Device suitable for mounting on "normally inflammable" surfaces		Recessed ceiling installation.
	Device with functional insulation, equipped with earth conductor.		Wall or ceiling installation.
	Low voltage device, less than 50V (Class III). Do not earth.		Lift/elevator installation.
	Designed, assembled and tested according to EC regulations 2006/95/CE BT - 2004/108/CE EMC		Marine installation.
	Constructed according to ATEX 94/9/CE		Automation sector.
	Indoor/outdoor wall and ceiling installation		Resistant to solvents
	Indoor wall and ceiling installation		Fire resistant
	Made in Italy		UV resistant
	New product		Italian Mark of Quality

### Degree of protection IP

Table 1	Protection against external solid foreign objects and against access to dangerous parts.	Table 2	Protection against harmful penetration of water.
0	Not protected	0	Not protected
1	Protected against solid foreign objects $\geq 50$ mm	1	Protected against vertical dripping
2	Protected against foreign objects larger than 12 mm	2	Protected against dripping water max. inclination of 15°
3	Protected against solid foreign objects larger than 2.5 mm	3	Protected against rainwater or spraying with max. inclination of 60°
4	Protected against solid foreign objects larger than 1 mm	4	Protected against splashing
5	Dust protected (no harmful deposits) protection against access with a wire	5	Protected against jets of water
6	Dust tight, protection against access with a wire	6	Protected against powerful jetting
		7	Protected against powerful jetting
		8	Protected against continuous immersion

### Abbreviations

<b>ESA</b>	<b>Discontinued – limited quantities available</b>	<b>S5</b>	<b>Protection IP65</b>
<b>S2</b>	<b>Protection IP54</b>	<b>S7</b>	<b>Protection IP67</b>
<b>S3</b>	<b>Protection IP55</b>	<b>S8</b>	<b>Protection IP68</b>

**Opz.** = options available (within the device). **Acc.** = accessories available (outside the device). **CS** = customised products (made to measure). **QM** = minimum quantity.

Abbreviations for the different tones of white light are: **WW** = Warm white. **NW** = Neutral white. **CW** = Cold white.

#### Coding system for lamps

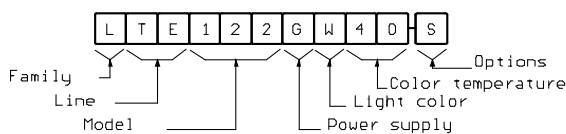

#### Coding system for panel meters

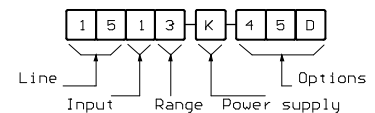

#### Coding system for customised products (CS)

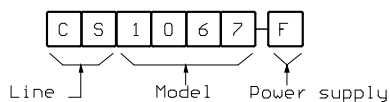

#### Coding system for accessories (Acc)

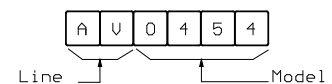



LIR1040



LIR1040 + AV0409



Applications



## Led downlight for indoor use, with emergency lighting, anti-vandal UNI-EN-81-71 standards

Integrated emergency light with separate circuit. Wall/recess mountings. Suitable for lift cars (two are sufficient to illuminate a 1000 x 1300 mm surface in accordance with energy/safety regulations), goods lift, car lift, electric panels, elevator shafts and engine rooms. Elegant and strong, designed for application in harsh environments and public installations. It is fire resistant and shockproof and conforms to anti-vandal requirements (UNI EN81-71, category 2).

### Technical specifications

- Light source: Led
- Body: polycarbonate
- Frame: polycarbonate or plastic
- Gloss finish: white, black or chrome (**Acc.**)
- Installation: screw
- Emission angle: 120°
- Main light: 10 led (6 emergency led)
- Colour temperature: neutral white (4000°K)
- Power supply: 10...30 Vdc
- Mounting: recessed, rear (wall/ceiling)
- Cable length 50 cm
- Protection class: IP68 front, IP40 rear
- Light intensity: 65 lux at 1 m (13 lux emergency)
- Protected against power surges
- Power consumption: 5 W complete (1 W emergency)
- Weight: ~ 100 g.

### Dimensions

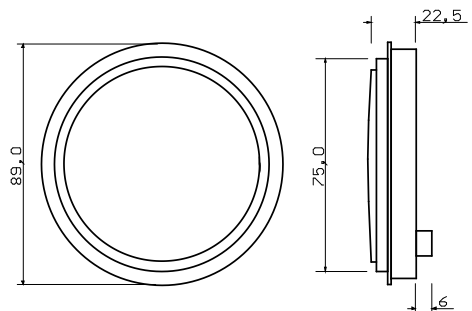

Code	Description	Code	Description
LIR1040K	Anti-vandal downlight, central body only	AV0408	Acc. - Black frame for wall mount
AV0404	Acc. - White frame for recess fitting	AV0409	Acc. - Plastic chrome frame for recess fitting
AV0405	Acc. - White frame for wall mount	AV0410	Acc. - Plastic chrome frame for wall mount
AV0407	Acc. - Black frame for recess fitting	AV0427	Acc. - Stainless steel frame for wall mount (ESA)

Fig. 1 – Wall fixing

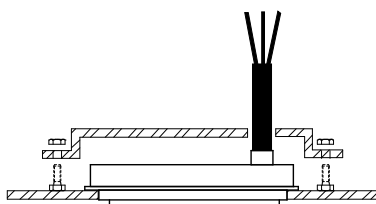

Fig. 2 – Recessed fixing

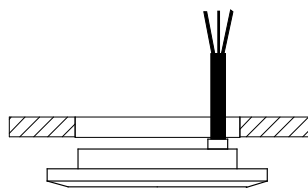
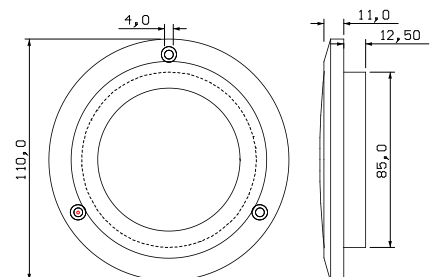

Fig. 3 – Dimensions recess lamp with frame



# IRIS, Plus, IE



*Underwater Led light, and for indoor/outdoor use*



IRIS, IRIS PLUS



Application



## IRIS, IRIS Plus, underwater Led surface mount lights, can also be applied for normal use

Robust and elegant (polycarbonate) case provides quick and economic installation. The frames are interchangeable and available in white, black and chromed, for surface and recessed mounting with screw fastening. No connection to the anodes. Suitable for little bridges, roll bars, awnings, cockpits, motor vain, galleys and bathrooms.

**Technical specifications**

- Polycarbonate case (also available in stainless steel – Acc.)
- Emission angle: 30°
- White light: (5700°K) or blue
- Sea cable: 2 m
- Power supply: 10...30 Vdc
- High protection class: IP68
- IRIS light intensity: 1430 lux (LIR611), underwater and normal use
- IRIS Plus light intensity: 2380 lux (LIR911), for underwater use only
- Protected against polarity inversion - Protected against power surges
- Low power consumption: 6 W or 9 W, long life
- Cut-out (only for passing wires): Ø 18 mm - Weight: ~ 230 g

**Dimensions**

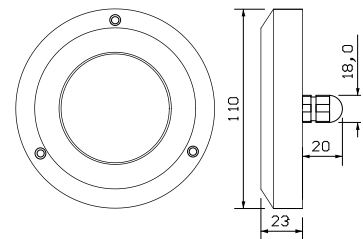

Codice	Descrizione	Codice	Descrizione
LIR611KW	IRIS, underwater light, white light (complete with frame AV0405)	AV0405	Acc. - White frame for surface mounting
LIR611KB	IRIS, underwater light, blue light (complete with frame AV0405)	AV0408	Acc. - Black frame for surface mounting
LIR911KW	IRIS Plus, underwater light, white light (complete with frame AV0405)	AV0427	Acc. - AISI316 Stainless steel frame for surface mounting (ESA)
LIR911KB	IRIS Plus, underwater light, blue light (complete with frame AV0405)	AV0467	Acc. - Plastic spacer to avoid cable hole, dim.Ø 110mm

IRIS IE



Application



## IRIS IE, Led downlights for interiors and exteriors, with white, red or blue courtesy light

Two colour polycarbonate Led downlights. Strong and elegant they are suitable for internal and external environments. Intense and uniform lighting with wide emission angle. White, red or blue (emergency) courtesy light. Interchangeable frame for surface or recessed mounting, available in white, black or chrome. Suitable for bathrooms, kitchens, cockpits, engine compartments, gangways and rollbars. The lower power consumption allows them to be used for emergency lighting.

**Technical specifications**

- Polycarbonate case
- Emission angle: 120°
- Main light white, courtesy light white, blue or red
- Neutral white light: 4500°K
- Power supply: 10...30 Vdc
- Protection class: IP44 or IP65
- Light intensity: 55 lux at 1 m (white light)
- Protected against polarity inversion
- Power consumption: 4 W lighting, 0,5/1 W courtesy - Protected against power surges
- Operating life: 30.000 hours @ 25°C - Cutout: Ø 86 mm - Weight: ~ 200 g

**Dimensions**

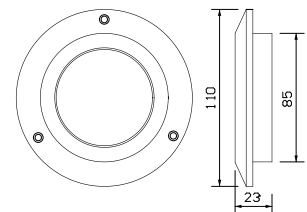

Code	Description	Code	Description
LIR72KWW	Downlight for interiors, NW, white courtesy, IP44	AV0404	Acc. - White frame, recess mount (standard supply)
LIR72KWB	Downlight for interiors, NW, blue courtesy, IP44	AV0405	Acc. - White frame, surface mount
LIR72KWR	Downlight for interiors, NW, red courtesy, IP44	AV0407	Acc. - Black frame, recess mount
LIR82KWW	Downlight for exteriors, NW, white courtesy, IP65	AV0408	Acc. - Black frame, surface mount
LIR82KWB	Downlight for exteriors, NW, blue courtesy, IP65	AV0409	Acc. - Chromed frame, recess mount
LIR82KWR	Downlight for exteriors, NW, red courtesy, IP65	AV0410	Acc. - Chromed frame, surface mount



LPT60KW40L



LPT75KW40



LPT5075KW40



Applications



### PUNTO, recess fitting Led downlight, for interiors/exteriors

Compact and elegant, suitable for classic and modern rooms. Aluminium alloy frame with chrome finish (white, gold or satin finish on request). Suitable for lift cars, elevator shafts, engine rooms, furniture, galleys, bathrooms, etc. The lower power consumption allows them to be used for emergency lighting.

#### Technical specifications

- Material: aluminium alloy
- Polycarbonate optical filter, transparent or prismatic diffuser (according to model)
- Frame: polished chrome standard (other optional)
- Spring fastening
- Emission angle: 120°
- Colour temperature: neutral white (4000°K)
- Power supply: 12...30 Vdc (PWM voltage dimmable)
- Installation; recess (wall/ceiling)
- Protection class: IP65/30 (IP65/65 with **Opt. S5**, LPT75 only)
- Light intensity: 55 lux at 1 m
- Without polarity, power consumption 2,5 W
- Cut-out: Ø 66,0 mm LPT75 - Ø 50,0 mm LPT60
- Weight: ~ 60g LPT75 – 42g LPT60

#### Dimensions

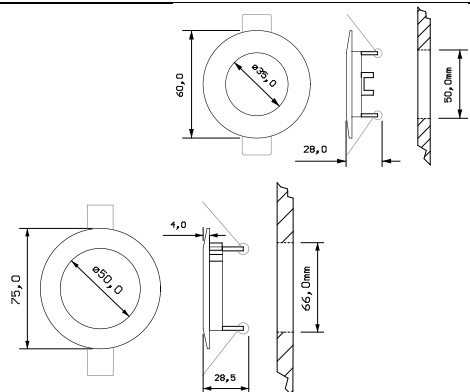

Code	Description	Code	Description
LPT60KW40T	Led downlight, 12...30Vdc, NW, 20 cm cable, chrome, transparent diffuser	<b>W</b>	<b>Opt.</b> – White frame
LPT60KW40L	Led downlight, 12...30Vdc, NW, 20 cm cable, chrome, prismatic diffuser	<b>D</b>	<b>Opt.</b> – Gold frame
LPT75KW40	Led downlight, 12...30Vdc, NW, 20 cm cable, chrome, transparent diffuser	<b>S5</b>	<b>Opt.</b> - Protection class IP65/65 (with 1,5mt cable)
LPT5075KW40	Replacement light, 12...30Vdc, neutral white light, 20 cm cable	<b>J</b>	<b>Opt.</b> – Satin finish frame



### ZEN 45, Led downlight, recess fitting, interiors/exteriors

Essential and space saving, very thin. Suitable for classic and modern environments. Chromed plastic frame. Suitable for lift cars, elevator shafts and engine rooms or for lighting closets, kitchens and/or bathrooms.

The low power consumption allows use in highly autonomous emergency installations. Quick and easy push to fit installation or screw fix.

#### Technical specifications

- Material: plastic
- Optical polycarbonate diffuser, prismatic (L) or transparent (T)
- Frame finish: polished chrome (Glossy black with **Opt. N**)
- Emission angle: 120°
- Colour temperature: neutral white (4000°K)
- Power supply: 12...30 Vdc (PWM dimmable in voltage)
- Installation: recess, push to fit or screw (supplied)
- Protection class: IP65 front (IP30 rear)
- Light intensity: 55 lux at 1 m (Prismatic), 80 lux (Transparent)
- Without polarity, power consumption 2,5 W
- Cut-out: Ø 41,0 mm
- Weight: ~ 20 g

#### Dimensions

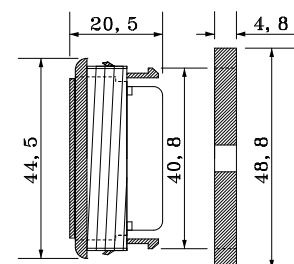

Code	Description	QM
LZE45KW40L	Led spotlight, 12...30 Vdc, neutral white light, 20 cm cable, IP65/30, prismatic diffuser	1
LZE45KW40T	Led spotlight, 12...30 Vdc, neutral white light, 20 cm cable, IP65/30, transparent diffuser	1
<b>N</b>	<b>Opt.</b> Glossy black frame	10

# VIOLA, VANDA

*Led downlight, rear recessed - Led downlight, adjustable  $\pm 20^\circ$ , wall, indoor*



Viola



Application

## VIOLA, Led downlight, rear recessed, IP44 protection class

Elegant structure in chromed brass. Intense and uniform illumination with a wide emission angle. Suitable for classic and modern environments. Standard polished chrome finish. Ideal for lighting cabins, galleys, cockpits, bathrooms or integrated directly into furniture. The lower power consumption allows them to be used for emergency lighting. Other finishes on request.

### Technical specifications

- Brass frame, without external casing, polished chrome finish
- Aluminium heatsink, natural anodized
- Aluminium fixing ring, natural anodized
- Emission angle:  $60^\circ$
- Recessed polycarbonate satin filter
- Light colour: warm white
- Power consumption: 4W
- Power supply: 24 Vdc,  $\pm 20\%$ , dimmable (ACD004)
- Protection class: IP44
- Light intensity: 190 lux at 1m
- Protected against power surges
- Installation: recess, rear seal O-ring
- Possibility of fixing with grub screws
- Dimensions:  $\varnothing 55 \times 41$  mm
- Cutout for power cable: min.  $\varnothing 56$ mm
- Weight: 220g

### Fixing system

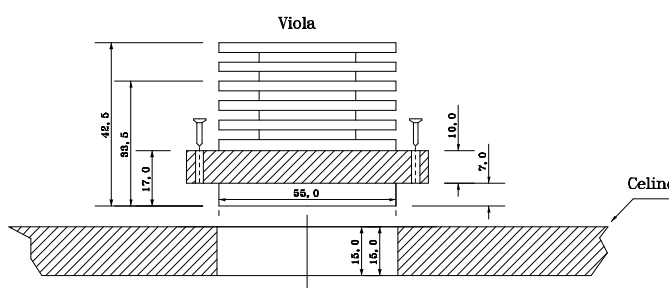

Code	Description	Code	Description	QM
LVL155GW30	Viola, Led downlight, rear recessed, WW, 24 Vdc	AV0493	Opt. – Steel spring fitting	5

Vanda

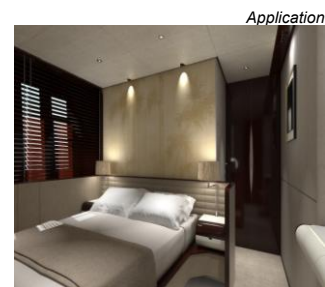

Application

## VANDA, Led downlight, adjustable $\pm 20^\circ$ , wall, indoor, also with earth

Elegant brass structure with a natural opaque finish. Intense and uniform illumination with a wide emission angle. Suitable for classic and modern environments. Wall mount. Ideal for lighting cabins, highlighting objects, sculptures, paintings, cabinets, or integrated directly into furniture. Other finishes available on request.

### Technical specifications

- Brass structure, natural opaque finish
- Aluminium heatsink, natural anodized
- Brass sleeve, natural opaque finish
- Emission angle:  $30^\circ$  adjustable  $\pm 20^\circ$
- Polycarbonate satin filter
- Warm white light: 3000°K
- Power consumption: 4W
- Power supply: 24 Vdc,  $\pm 20\%$ , dimmable (ACD004)
- Protection class: IP44
- Light intensity: 190 lux at 1m
- Protected against power surges
- Wall mount, cutout for power cable  $\varnothing 11$ mm
- Dimensions:  $\varnothing 35 \times 50$  mm - Weight: 200 g (complete with driver, 25 g.)

### Dimensions

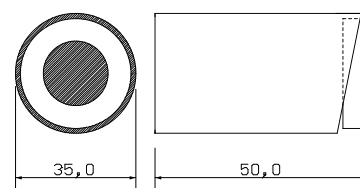

Code	Description	QM
LVA135GW30	Led downlight, adjustable $\pm 20^\circ$ , 4W, power supply 24 Vdc, warm white light	1



Applications



### SABA, chrome plated brass Led downlights, recess fitting, for interiors

Elegant chrome plated brass structure. Intense and uniform lighting with a wide emission angle. Suitable for classical and modern environments. Standard polished finish. Ideal for lighting cabins, galleys, cockpits, bathrooms or integrated directly into furniture. Their low power consumption allows them to be used for emergency lighting. Other finishes on request.

#### Technical specifications

- Brass casing, polished chrome finish
- Anodized anticorrosive aluminum heat sink
- Emission angle: 90° (70° with recess)
- Satin finish polycarbonate filter
- Warm white light (3000°K)
- Power consumption: 4 W
- Power supply: 24 Vdc, ±20%, dimmable (ACD004)
- Protection class standard: IP44 front, IP20 rear
- Protection class for external use: IP65 (**Opt. "S5"**)
- Light intensity: 110 lux at 1m
- Protected against power surges
- Installation: recess, stainless steel spring fitting
- Dimensions: Ø 65 x 34 mm
- Cut-out Ø 58mm
- Weight: ~ 155 g (complete with driver, 25 g.)

#### Dimensions

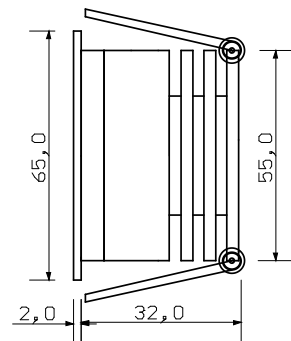

Code	Description	Code	Description
LSA165GW30	Led downlight, polished chrome, 4W, 24 Vdc, warm white	S5	Opt. – Protection class IP65

Exploded view of downlight with spacer for filter recess

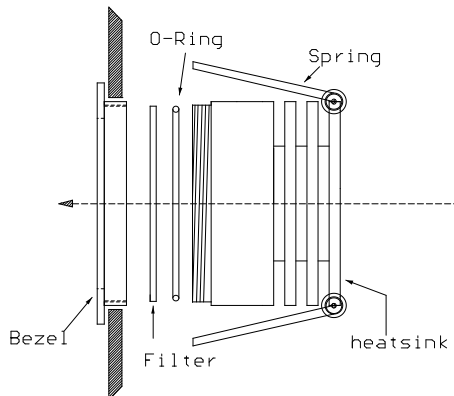

Downlight with recessed filter





### MINI, Led downlight, recess, indoor/outdoor

Elegant anodized aluminium casing. Intense and uniform lighting. Suitable for classic and modern environments. Standard black opaque finish, white RAL 9010 on request. Ideal for cabins, galleys, cockpits, bathrooms, corridors, etc. The low consumption allows them to be used even in emergency systems.

#### Technical specifications

- Ceiling or wall mounting
- Stainless steel spring fitting
- Protection class: IP44/20 (IP65 with **Opt. "S5"**)
- Opaque black finish (white with **Opt. "W"**)
- Emission angle 35°
- Potency: 440 lm
- Prismatic lens filter
- Colour temperature: warm white 3000°K (or red)
- Power consumption: 4 W
- Power supply: 24 Vdc, ±20%, dimmable (ACD004)
- Light intensity: 520 lux at 1m
- Protected against power surges
- Dimensions: Ø 46 x 50 mm
- Cutout: Ø 42 mm
- Weight: ~ 107 g (complete with driver, 25g)

#### Dimensions

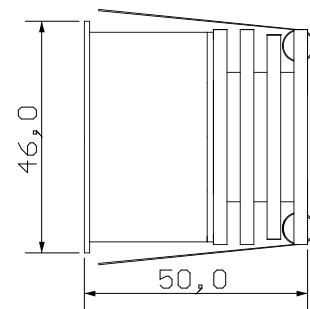

Code	Description	Code	Description	QM
LMI146GW30	MINI, Led downlight, aluminium, opaque black finish, power supply 24 Vdc, warm white light, IP44/20	S5	Opt. – Protection class IP65	10
LMI146GR	MINI, Led downlight, aluminium, opaque black finish, power supply 24 Vdc, red light, IP44/20	W	Opt. – White RAL 9010 frame	10
40	Opt. – Neutral white light NW			10

Exploded view with option "S"

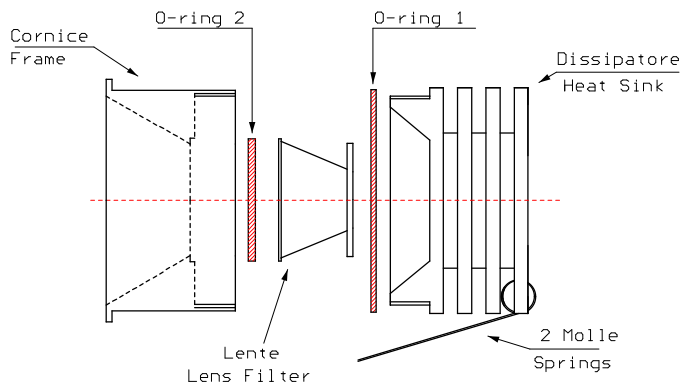

Typical use for MINI with option "S"



# TUBO, TUBO 340



Led downlight, wall mount, for interiors/exteriors



Tubo



Application



## TUBO, wall mount chrome plated brass Led spotlight, for interiors and exteriors

Elegant structure offering uniform lighting with a wide radius. Suitable for classic and modern environments. Ideal for illuminating prominent areas, cabinets, cabins, galleys, kitchens, tables, etc. Other finishes on request.

### Technical specifications

- Brass frame, polished chrome finish
- Fixing base: anodized anticorrosive aluminium
- Emission angle: 90°
- Satin finish polycarbonate filter
- Warm white light: 3000°K
- Power consumption: 4 W
- Power supply: 10...30 Vdc, dimmable (ACD004)
- Protection class standard: IP44 front, IP20 rear
- Protection class for external use: IP65 (Opt. "S5")
- Light intensity: 110 lux at 1m
- Protected against power surges
- Wall mount
- Screw fitting
- Cable length: 100 cm
- Cut-out (for power cable): Ø 8 mm
- Weight: ~ 95 g (complete with driver, 25 g.)

### Dimensions

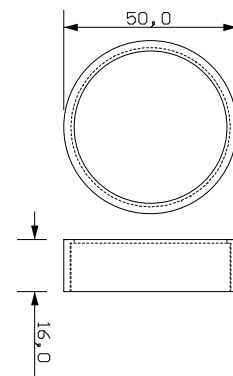

Code	Description	Code	Description	QM
LTU216KW30	Led spotlight, polished chrome, Power supply 10...30Vdc, warm white	S5	Opt. – Protection class IP65	10



## TUBO 340, LED pendant lamp, IP44, recessed

Compact and elegant spotlights, suitable for both classic and modern settings. Intense, uniform light with a wide beam angle. Suitable for interior lighting, such as living rooms, tables, display cases, etc. Housing with a glossy black lacquer finish, other finishes available upon request.

### Technical specifications

- Brass housing: glossy black finish (other finishes available on request)
- Illumination cone: 40°
- Optical filter: satin-finish polycarbonate, recessed
- Light: warm white, 3000K
- Power consumption: 4W
- Power supply: 24 VDC (22...30), dimmable (ACD004)
- Protection rating: IP44
- Power cable: 130cm, black
- Light intensity: 250 lux at 1m
- Protected against voltage spikes
- Pendant mounting
- Screw fixing
- Hole for power cable, Ø 12mm
- Dimensions Ø 50 x 400mm

### Application



Code	Description	QM
LTU340GW30	Pendant fixture, glossy black, 24Vdc, 4W, warm white light	1



POLA



Applications



### POLA Led downlights, recess fitting, for exteriors, protection class IP65

Compact and elegant downlights, suitable for classical and modern environments. Intense and uniform lighting with a wide emission angle. Aluminium casing with satin finish PMMA filter. Suitable for all exteriors such as platforms, rollbars, cockpits, gangways etc.

Technical specifications	Dimensions	Exploded view Pola	QM
<ul style="list-style-type: none"> <li>Satin finish PMMA filter</li> <li>Anodized anticorrosive aluminium heat sink</li> <li>Emission angle: 70°</li> <li>Warm white light: 3000°K</li> <li>Power consumption: 4 W</li> <li>Power supply: 10...30 Vdc, dimmable</li> <li>Protection class: IP65</li> <li>Light intensity: 110 lux at 1m</li> <li>Protected against power surges</li> <li>Installation: recess, screw fitting</li> <li>Cut-out: Ø 65 mm</li> <li>Weight: ~ 190 g. (complete with driver, 25 g.)</li> </ul>			<p><b>LPO180GW30</b> Pola, Led downlight, PMMA filter, 4W, Power supply 10...30 Vdc, warm white light, 80x40mm</p> <p>5</p>

MIGNON



Application



### MIGNON Led downlights, recess fitting, for exteriors, protection class IP65

Compact and elegant downlights, suitable for classical and modern environments. Intense and uniform lighting with a wide emission angle. Aluminium casing with satin finish PMMA filter. Suitable for all exteriors such as platforms, rollbars, cockpits, gangways etc.

Technical specifications	Dimensions	Exploded view Mignon	QM
<ul style="list-style-type: none"> <li>Satin finish PMMA filter</li> <li>Anodized anticorrosive aluminium heat sink</li> <li>Emission angle: 40°</li> <li>Warm white light: 3000°K</li> <li>Power consumption: 4 W</li> <li>Power supply: 10...30 Vdc, dimmable</li> <li>Protection class: IP65</li> <li>Light intensity: 140 lux at 1m</li> <li>Protected against power surges</li> <li>Installation: recess, screw fitting</li> <li>Cut-out: Ø 33 mm</li> <li>Weight: ~ 85 g. (complete with driver, 25 g.)</li> </ul>			<p><b>LPO149KW30</b> Mignon, Led downlight, PMMA filter, 4W, Power supply 10...30 Vdc, warm white light, 49x32mm</p> <p>5</p>



AV0411



AV0414



### PERLA, Led courtesy lights, for interiors and exteriors, protection class IP67

Small and bright Led lights available in cold white, blue, red, green or amber tones. The single block case and internal resin finish makes them completely watertight. Extremely simple and fast to install, they can be screwed in and fastened with a hex nut (supplied) or glued. Useful for illuminating borders or cabins, electrical panels, handrails or simply as courtesy lights.

Technical specifications			Dimensions			Applications		
<ul style="list-style-type: none"> <li>Transparent polycarbonate case</li> <li>Emission angle 30°</li> <li>Light colours: white, blue, red, green and amber</li> <li>20 cm cable</li> <li>Power supply: 10...30 Vdc</li> <li>Protection class: IP67</li> <li>Light intensity: 20 lux at 1 m</li> <li>Without polarity - Thread: 12 MA x 1,5</li> <li>Power consumption: 0,3 W (12V), 0,6W (24V)</li> <li>Cut-out: Ø 12 mm</li> <li>Weight: ~ 7 g.</li> </ul>								
Code	QM	Description	Code	QM	Description			
LPE112KW	10	PERLA, White courtesy light, with hex nut	LPE112KA	10	PERLA, Amber courtesy light, with hex nut			
LPE112KB	10	PERLA, Blue courtesy light, with hex nut	AV0411	1	Acc. - Chromed brass frame, Ø 24 x 6 mm			
LPE112KR	10	PERLA, Red courtesy light, with hex nut	AV0414	1	Acc. - Golden brass frame, Ø 24 x 6 mm			
LPE112KG	10	PERLA, Green courtesy light, with hex nut	SL	20	Opt. - Color uniformity selection			



AV0391



AV0491



### GEMMA, Led courtesy lights, for interiors and exteriors, protection class IP67

Small and bright Led lights available in cold white, blue, red, green or amber tones. The single block case and internal resin finish makes them completely watertight. Extremely simple and fast to install, they can be fastened with a hex nut (supplied) or glued. Useful for illuminating borders or cabins, electrical panels, handrails or simply as courtesy lights.

Technical specifications			Dimensions			Applications		
<ul style="list-style-type: none"> <li>Transparent polycarbonate case</li> <li>Emission angle 30°</li> <li>Light colours: white, blue, red, green and amber</li> <li>20 cm cable</li> <li>Power supply: 10...30 Vdc</li> <li>Protection class IP67</li> <li>Light intensity: 20 lux at 1 m</li> <li>Without polarity - Thread: 12 MA x 1,5</li> <li>Power consumption: 0,3 W (12V), 0,6W (24V)</li> <li>Cut-out: Ø 12 mm</li> <li>Weight: ~ 7 g.</li> </ul>								
Code	QM	Description	Code	QM	Description			
LGE118KW	10	GEMMA, White courtesy light, with hex nut	LGE118KA	10	GEMMA, Amber courtesy light, with hex nut			
LGE118KB	10	GEMMA, Blue courtesy light, with hex nut	AV0391	1	Acc. - Round stainless steel frame, Ø 32 x 4mm			
LGE118KR	10	GEMMA, Red courtesy light, with hex nut	AV0491	1	Acc. - Square chromed brass frame, 30x30x4mm			
LGE118KG	10	GEMMA, Green courtesy light, with hex nut	SL	20	Opt. - Color uniformity selection			



LCS2KW40



LCS2KW40 + AV0411



LCS3KW40



### STELLA, Led spot, for interiors, IP67 front, IP40 rear

Small and bright neutral white Led lamps. Extremely simple and fast to install, they can be fastened with a hex nut (supplied) or glued. Useful for illuminating borders or cabins, electrical panels, handrails, night sky lights or simply as courtesy lights.

#### Technical specifications

#### Applications

- Transparent polycarbonate case
- Emission angle 90°
- Neutral white light: 4000°K
- 50 cm cable, pre-wired with connector (F)
- Power supply: 10...30 Vdc
- Protection class: IP67 front, IP40 rear
- Light intensity: 15 lux at 1 m
- Protected against power surges, without polarity
- Thread: 12 MA x 1,5 - Power consumption: 0,5 W
- Dimensions: Ø 12 x 26 mm (LCS2) or Ø 18 x 12 x 26 mm (LCS3), cutout Ø 12 mm
- Weight: ~ 8 g.



Code	QM	Description	Code	Description
LCS2KW40	10	STELLA, Led spot, 50 cm cable pre-wired with M connector, supplied with hex nut	LCS3KW40	STELLA, Led spot, 50 cm cable pre-wired with M connector, supplied with hex nut
AV0411	1	Acc.- Chromed brass frame, Ø 24 x 6mm (LCS2)	AV0391	Acc. – Stainless steel frame, Ø 32x4mm (LCS3)
AV0414	1	Acc.- Golden brass frame, Ø24x6mm (LCS2)	AV0491	Acc.- Chromed brass frame, 30x30x4mm (LCS3)



### SPILLO, Led step lights, recess fitting, for interiors/exteriors

Elegant PMMA body. Intense and uniform lighting with a wide emission angle. Suitable for classical and modern environments. Satin finish, also with chrome plated frame and casing. Ideal for floor lighting, steps, borders, davits, cockpits, gangways, bathrooms, lockers, etc.

#### Technical specifications

#### Applications

- PMMA body, satin finish
- Emission angle: 90°
- Chromed brass bezel (Acc.)
- White/neutral PVC casing (Acc.)
- Colour temperature: warm white 3000°K (neutral 4000°K - Opz.)
- Power consumption: 0,5 W
- Power supply: 12/24 Vdc
- Protection class: IP67 front, IP20 rear
- Light intensity: 15 lux at 1 m
- Protected against power surges, without polarity
- Recess fitting, push to fix (o-ring) or glued
- Bulb dimensions: Ø 23 x 25,5 mm (cut-out Ø 16 mm), weight: ~ 12 g.
- Dimensions bulb with bezel and casing: Ø 35 x 25,5mm (cut-out Ø 20mm), weight: ~ 60 g.

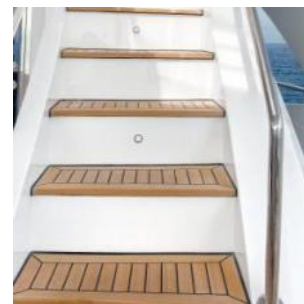

Code	QM	Description	Code	QM	Description
LSL123GW30	10	Spillo, Led bulb, warm white light, 10...30 Vdc	AV0487	10	Acc. Casing for Spillo bulb
40	50	Opt. – Neutral white light (4000°K)	AV0488	10	Acc. Bezel for Spillo bulb

Giglio 1



Formwork



## GIGLIO 1, recessed LED courtesy lights, for indoor/outdoor use, IP65 or IP67

Small, bright white or blue LED lamps. The one-piece housing and resin coating make them waterproof. They offer quick and easy installation as they can be embedded into the materials, glued, and sealed with two O-rings. Suitable for marking out or illuminating cabins, electrical panels, handrails, or even as simple indicator lights.

Technical specifications			Dimensions			Application
<ul style="list-style-type: none"> <li>Polished chrome-plated brass housing</li> <li>Lighting cone: 30° horizontal</li> <li>Models with light: white (4000°K) or blue</li> <li>Cable outlet: 30 cm (220 cm, M+F connector - IP67)</li> <li>Power supply: 24Vdc (22...30Vdc)</li> <li>Mounting: pressure-fit</li> <li>Light intensity: 23 lux at 1 m</li> <li>Non-polarity</li> <li>Power consumption: 0.6W</li> <li>Overall dimensions: Ø 25 x 21mm</li> <li>Hole for formwork fixing: Ø 18mm</li> <li>Weight: ~7g.</li> <li>Note: The formwork is not included with the courtesy light</li> </ul>						

Code	QM	Description	Code	QM	Description
LGI121GW40	10	Giglio1, NW light, 24Vdc, IP65, 30 cm wires	LGI127GB	10	Giglio1, Blue light, 24Vdc, IP67/67, M+F connector
LGI127GW40	10	Giglio1, NW light, 24Vdc, IP67/67, M+F connector	30	10	Opt. Warm white light option, 3000°K
LGI121GB	10	Giglio1, Blue light, 24Vdc, IP65, 30 cm wires	AV0505	10	Acc. Formwork, plastic, 19 x 18 mm

Giglio 2



Formwork



## GIGLIO 2, recessed LED courtesy lights, for indoor/outdoor use, side lighting, IP65 or IP67

Small, bright white or blue LED lamps. The one-piece housing and resin coating make them waterproof. They offer quick and easy installation as they can be embedded into the materials, glued, and sealed with two O-rings. Suitable for marking out or illuminating cabins, electrical panels, handrails, or even as simple indicator lights.

Technical specifications			Dimensions			Application
<ul style="list-style-type: none"> <li>Polished chrome-plated brass housing</li> <li>Lighting cone: 30° lateral</li> <li>Models with light: white (4000°K) or blue</li> <li>Cable outlet: 30 cm (220 cm, M+F connector - IP67)</li> <li>Power supply: 24Vdc (22...30Vdc)</li> <li>Mounting: pressure-fit</li> <li>Light intensity: 10 lux at 1 m</li> <li>Non-polarity</li> <li>Power consumption: 0.6W</li> <li>Overall dimensions: Ø 25 x 30mm</li> <li>Hole for formwork fixing: Ø 18mm</li> <li>Weight: ~7g.</li> <li>Note: The formwork is not included with the courtesy light</li> </ul>						

Code	QM	Description	Code	QM	Description
LGI221GW40	10	Giglio2, NW light, 24Vdc, IP65, 30 cm wires	LGI227GB	10	Giglio2, blue light, 24Vdc, IP67/67, M+F connector
LGI227GW40	10	Giglio2, NW light, 24Vdc, IP67/67, M+F connector	30	10	Opt. Warm white light option, 3000°K
LGI221GB	10	Giglio2, blue light, 24Vdc, IP65, 30 cm wires	AV0505	10	Acc. Formwork, plastic, 19 x 18 mm



### AMBRA, Led lamps for difficult areas, IP65 and IP67

High brightness lamps, extremely robust, with IP65 and IP67 protection. Intense and uniform Led light, with a wide emission angle. Designed for use in harsh environments such as: workshops, engine compartments and bilges of vessels, machine compartments of elevators and in trucks, vans, campers, etc..

#### Technical specifications

- Power supply: 12 or 24 Vcc ( $\pm 20\%$ )
- Protected against power surges
- Power consumption: 4.2 W (8 W)
- Emission angle:  $140^\circ$
- Light intensity: 220 lux (370 lux) at 1m
- Light intensity:  $4000^\circ\text{K}$
- Operating temperature range:  $-10 \dots +60^\circ\text{C}$
- Operating life: 30.000 h at  $25^\circ\text{C}$
- Casing: polycarbonate  $\varnothing 26$  mm
- Dimensions:  $\varnothing 26 \times 250$  mm (510 mm)
- Cable length: 30 cm
- Protection class: IP65 (IP67 with **Opt. S7**)
- Weight:  $\sim 90$  g. (140 g.)

#### Dimensions Clip AV0503

#### Clip AV0503

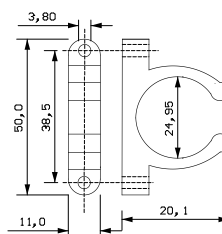

Code	Description	QM
LAM125GW40	Ambra, Led lamp, 24Vcc, $\varnothing 26 \times 250$ mm, IP65, 220 lux, NW, 4,2 W	1
LAM125FW40	Ambra, Led lamp, 12Vcc, $\varnothing 26 \times 250$ mm, IP65, 220 lux, NW, 4,2 W	1
LAM151GW40	Ambra, Led lamp, 24Vcc, $\varnothing 26 \times 250$ mm, IP65, 370 lux, NW, 10 W	1
LAM151FW40	Ambra, Led lamp, 12Vcc, $\varnothing 26 \times 250$ mm, IP65, 370 lux, NW, 10 W	1
S7	Opt. – Protection class IP67	5
AV0503	Pair fixing clasps (one kit supplied with lamp)	

#### Dimensions

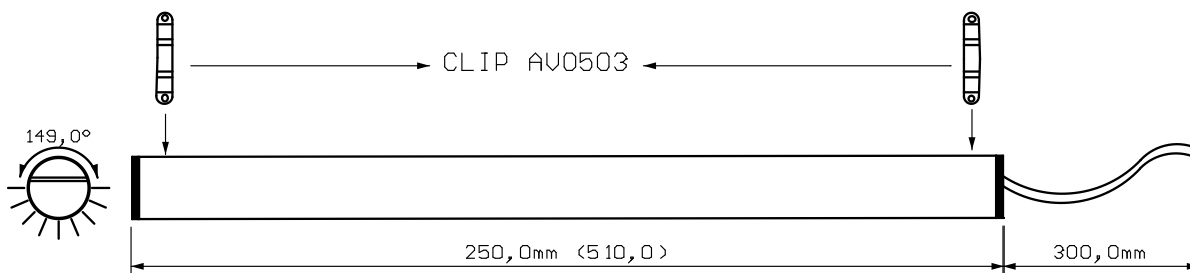

# MATTONELLA, TECLA

Led lamp, with courtesy light and emergency function  
 Led lamps for technical rooms, wall mount



Applicazioni

## MATTONELLA, Led lamp, wall mount, with courtesy light and emergency function

Elegant white plastic casing. Intense and uniform lighting with a wide emission angle. Version with triple mode lighting: complete, courtesy and emergency (LMT28BFW40 only). Neutral white light, suitable for lift cars, cabins, engine rooms, elevator shafts, or electric anels.

### Technical specifications

- Light source: Led
- Material: plastic, polished white finish
- Screw installation
- Standard circuit: double (complete and courtesy)
- Pre-wired circuit: triple (complete, courtesy and emergency)
- Emission angle: 120°
- Colour temperature: neutral white (4000°K)
- Power supply: 12 Vdc (11...15), 24 Vdc (22...30)
- Mounting: wall/ceiling
- Light intensity: 350 Lux at 1m (100 Lux at 2m)
- Protection class: IP50 (IP54 with **Opt. S2**)
- Protected against power surges
- Power consumption: 10 W complete, 1 W courtesy, 0,5 W emergency
- Operating temperature range: -10...+50°
- Weight: ~ 500g

### Applications

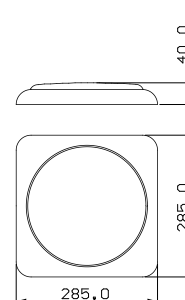

Code	Description	Code	Description
LMT28FW40	Led lamp, 12Vdc, neutral white, double circuit	AV0476	Acc. Rechargeable back up battery, 12Vdc – 1,3 Ah
LMT28GW40	Led lamp, 24Vdc, neutral white, double circuit	AV0481	Acc. Pre-wired power supply, 6 outputs, and battery charger
LMT28BFW40	Led lamp, 12 Vdc, neutral white, pre-wired, triple circuit (ESA)	AV0486	Acc. Pair of cables for pre-wired system, 150 cm
S2	Opt. – Protection class IP54	AV0495	Acc. Power supply for pre-wired system, 2 outputs



## TECLA, Led lamps for technical rooms, wall mount

Designed to replace halogen or neon lamps. Elegant white plastic casing, suitable for lighting engine rooms or technical areas on small or large vessels. Wall mount. Intense and uniform lighting with a wide emission angle and neutral white light. Resistant to overheating and vibrations. Incorporated ON/OFF power switch. The low voltage power supply allows them to be used for emergency lighting.

### Technical specifications

- Plastic white casing (RAL 9003)
- Satin finish filter
- Power consumption: 6W
- Neutral white lamp: 4000°K
- Emission angle: 120°
- Power supply standard: 24 Vdc (12 Vdc on request)
- Light intensity: 230 Lux at 1 m
- Protection class: IP50 (IP54 with **Opt. "S2"**)
- Incorporated ON/OFF switch
- Protected against power surges
- Wall mount, screw fix
- Weight: ~ 140 g

### Dimensions

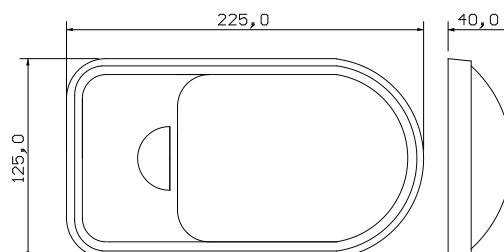

Code	Description	QM
LTE122FW40	TECLA, Led lamp, 12Vdc power supply, white casing, neutral white light (6W), on request	1
LTE122GW40	TECLA, Led lamp, 24Vdc power supply, white casing, neutral white light (6W), standard	1
LAX312FW40	Led bulb, retrofit for turtle ceiling light (Tecla/Atex), neutral white light, 12 Vdc power supply, 120 x 65 mm	10
LAX312GW40	Led bulb, retrofit for turtle ceiling light (Tecla/Atex), neutral white light, 24 Vdc power supply, 120 x 65 mm	10
S2	Opt. – IP54 protection treatment	10

# MODA, SIBILLA

Modular Led lighting, wall mount

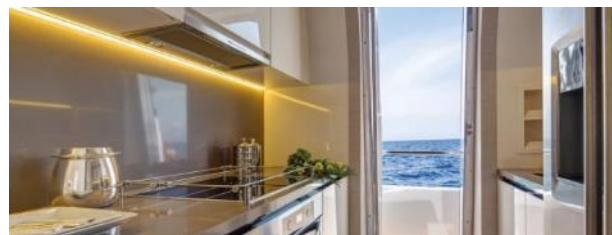

## MODA, linear Led profile, aluminium body, wall mounting, for interiors

Ideal for cabins, engine rooms, electrical panels, cockpits. Silver anodized aluminium body, polycarbonate filter with satin or opaline finish (optional), UV resistant.

### Technical specifications

- 4 standard sizes
- Emission angle 120°
- Power supply: 24 Vdc (12 Vdc **Opt**)
- Operating temperature range: 0...+60°C
- Light intensity: 140 lux at 1 m (LMO151GW40)
- Protected against power surges
- Standard filter: satin (opaline **Opt.**)
- Closing plugs: grey PVC
- Steel fixing clasps (2 included in package), 19 x 9 mm

### Dimensions

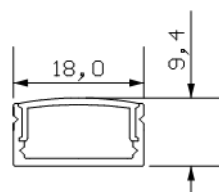

### Fixing clasp AV0429



Code	Description	Weight g.	Protection	Colore	W	Power supply	Length
LMO122GW40	Led lamp, neutral white light, satin filter	38	IP30	4000°K	3	24 Vdc	22 cm
LMO151GW40	Led lamp, neutral white light, satin filter	85	IP30	4000°K	7	24 Vdc	51 cm
LMO171GW40	Led lamp, neutral white light, satin filter	125	IP30	4000°K	10	24 Vdc	71 cm
LMO199GW40	Led lamp, neutral white light, satin filter	170	IP30	4000°K	14	24 Vdc	99 cm
F	<b>Opt.</b> - Power supply 12 Vdc		<b>30</b>	<b>Opt.</b> - Warm white light, 3000°K			
UP	<b>Opt.</b> - Rear exit of power supply wires		<b>OP</b>	<b>Opt.</b> - Opaline filter			
S	<b>Opt.</b> - Protection class IP55		<b>AV0429</b>	<b>Acc.</b> - Kit 2 steel fixing clasps, 19 x 9 mm			



## SIBILLA, linear Led profile, in transparent methacrylate case, wall mounting, for interiors/exteriors

Ideal for cabins, engine rooms, electrical panels, cockpits, lockers, and awnings.

### Technical specifications

- 4 standard sizes
- Emission angle 120°
- Power supply: 24 Vdc (12 Vdc **Opz**)
- Operating temperature range: 0...+50°C
- Light intensity: 100 lux at 1 m (LSI151GW40)
- Protected against power surges
- Closing plugs: black PVC
- Fixing clasps: metal (sold separately)
- Fixing clasps: plastic (sold separately)

### Dimensions

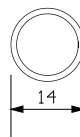

### Metal fixing clasp

AV0425



### Plastic fixing clasp

AV0426



Code	Description	Weight g.	Protection	Colour	W	Power supply	Length
LSI122GW40	Led lamp, neutral white light	30	IP54	4000°K	3	24 Vdc	22 cm
LSI151GW40	Led lamp, neutral white light	70	IP54	4000°K	7	24 Vdc	51 cm
LSI171GW40	Led lamp, neutral white light	100	IP54	4000°K	10	24 Vdc	71 cm
LSI199GW40	Led lamp, neutral white light	140	IP54	4000°K	14	24 Vdc	99 cm
F	<b>Opt.</b> - Power supply 12 Vdc		<b>AV0425</b>	<b>Acc.</b> - Kit 2 metal fixing clasps, 42 x 12 mm, inter. 30 mm			
30	<b>Opt.</b> - Warm white light, 3000°K		<b>AV0426</b>	<b>Acc.</b> - Kit 2 plastic fixing clasps, 37 x 15 mm			

# LUXBOMA, TOUCH

*Led lamp, wall mount, with courtesy light and touch switch*



## LUXBOMA, Led lamp, with courtesy light, can be inserted under the boom

Led lamp for cockpit lighting. Elegant finish, reduced dimensions, long duration and low power consumption. Single model, with two types of fixing, screw or insertion directly into the lower groove of the boom (eg. for Selden™ and Sparcraft™). Also ideal for other uses, under crosstrees, rollbars and awnings, motor vains, etc.

### Technical specifications

- Anodized aluminium case
- Emission angle 60°
- Cold white light (5800°K)
- Courtesy light: red
- Sea cable, 40 cm
- Power supply: 10...30 Vdc
- Protection class: IP66
- Light intensity: 450 lux at 1 m
- Protected against polarity and power surges
- Low power consumption: 6 W (white light), 1 W (red light)
- Operating temperature range: -10...+60°C
- Weight: 130g

### Dimensions

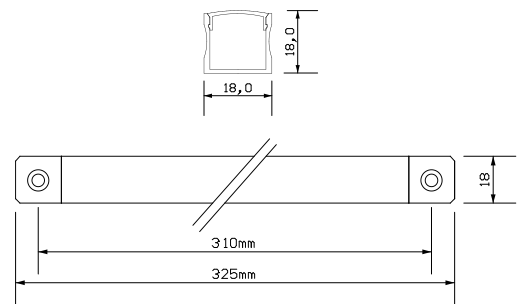

**Codice**      **Descrizione**

**LXB830KWR**      Luxboma, Led lamp, wall mount, white light with red courtesy, screw fix, protection class IP66

**QM**

1



## TOUCH, Led lamp, wall mount, with ON/OFF touch switch, also suitable for heavy duty use

Ideal for use in environments such as cabins, engine rooms, electrical panels, cockpits, engine rooms, under crosstrees, rollbars and awnings etc. Reduced dimensions, long duration and low power consumption.

### Technical specifications

- Transparent polycarbonate case
- Emission angle 90°
- Neutral white light (4000°K)
- Power supply: 12...30 Vdc, cable 50cm
- Protection class: IP54
- Light intensity: 136 lux at 1 m
- Protected against power surges
- Low power consumption: 4 W, long life
- Fixing clasps: transparent plastic (2 supplied)
- Dimensions: 11 x 12.6 x 360mm
- Weight: ~ 50g

### Fixing clasps

### Lamp dimensions

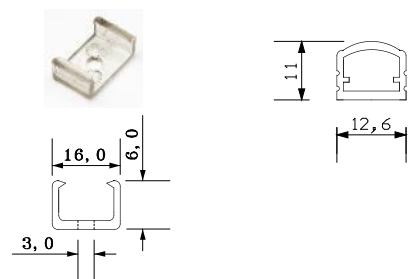

**Code**      **Description**

**LTO936KWT**      TOUCH, wall mount Led lamp, neutral white light, power supply 12...30 Vdc, IP54, ON/OFF touch switch

**AV0498**      Acc. - Kit 2 plastic fixing clasps, 16 x 6mm

**QM**

1

10

Set up diagram LUXBOMA

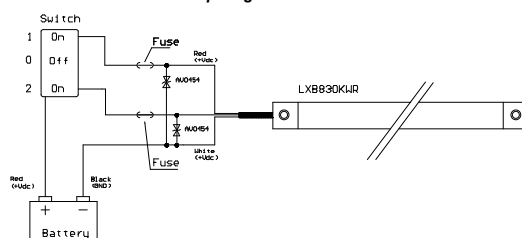

Set up diagram TOUCH

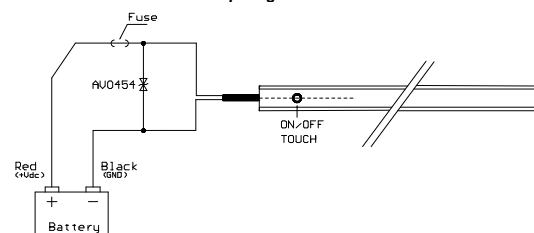

*Led lamp, wall mount, for technical rooms, also with dual power supply 230Vac/24Vdc and emergency circuit*

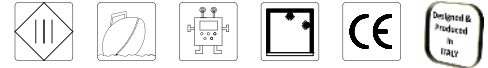

### ILOGO, Led lamp, wall mount, for technical rooms, also with dual power supply 230Vac/24Vdc

Designed to replace neon lamps. They are inserted in an elegant aluminium structure, suitable for lighting technical rooms of medium and large vessels. The pressure fixing system is simple, avoiding the need to drill holes, greatly reducing installation time. The illumination is intense and uniform with a wide emission angle, with a neutral white light. The dual power supply model has two separate circuits, allowing the lamp to be powered at both 230Vac and 24Vdc (e.g. emergency circuit).

#### Technical specifications

- Light source: Led
- Casing: aluminium, natural anodised finish
- Installation: wall or ceiling mount with pressure clips (2 supplied)
- Fixing: two spring clips (supplied)
- Heatsink: anodized anticorrosional aluminium
- Emission angle: 120°
- Opaline finish filter
- Neutral white light: 4200°K
- Power consumption: 20W (230mA)
- Single power supply: 10...30Vdc (code **K**) or 230 Vac – 50Hz
- Dual power supply: 230 Vac and 24Vdc (code **G**)
- Protection class: IP50 (IP54 with **Opt. S2**)
- Light intensity: 400 Lux at 1m (also in Emergency)
- Luminous flux: 1800 lm
- Cable: 25cm
- Protected against power surges
- Weight: ~ 185 g

#### Side view and fixing system

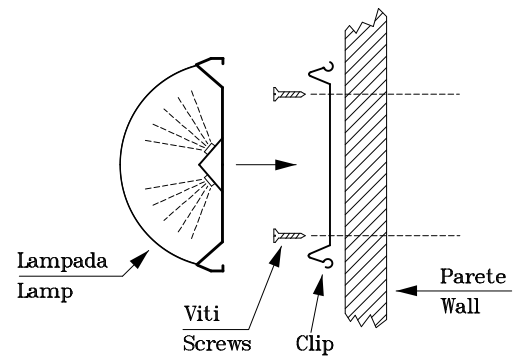

Code	Description	QM
<b>LIL160AW40</b>	llogo, power supply 100...240 Vac (20W), NW, IP54 (ex LRFL20W60CW)	1
<b>LIL160AW40-G</b>	llogo, dual power supply 100...240 Vac (20W) and 24Vdc (20W), NW, IP54 (ex LRFL20W60CW-G)	1
<b>LIL160KW40</b>	llogo, power supply 10...30 Vdc (20W), NW, IP54 (ex LRFL20W60CW-K)	1
<b>LIL160AW40-E</b>	llogo, power sup.100...240 Vac (20W), and emergency circuit 24Vdc (5W), NW, IP54 (ex LRFL20W60CW-E)	1
<b>S2</b>	<b>Opt.</b> – IP54 protection treatment 	10

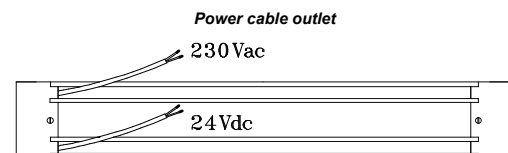
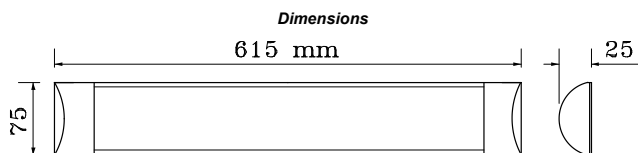

Rear view

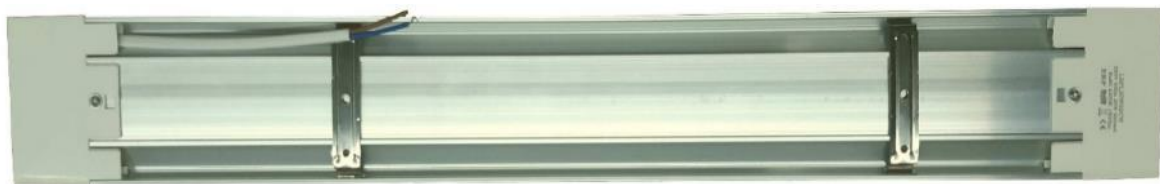

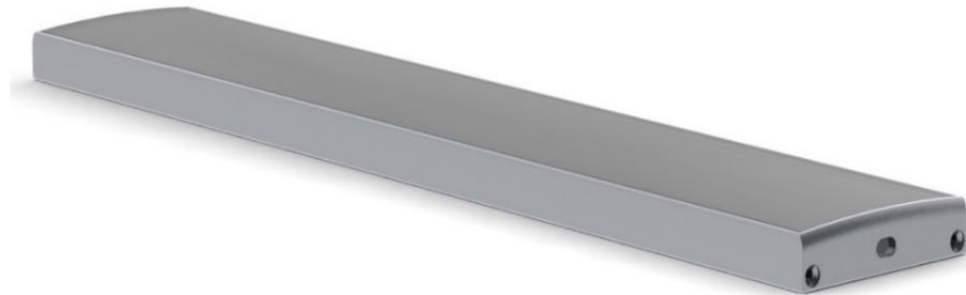

### SELENE, Led lamp for technical rooms, wall mount, also available with IP65 protection class

Designed to replace halogen or fluorescent lamps. Elegant anodized aluminium frame, natural silver in colour, suitable for lighting engine rooms on small and large vessels. Wall mount, for ceilings or walls. Intense and uniform illumination with a wide emission angle and a neutral white light. Does not overheat or suffer from vibrations. The low voltage power allows for use in emergency circuits.

#### Technical specifications

- Aluminium casing
- Lamp colour: natural silver
- Opaline filter
- Power consumption: 7W or 14W or 21W
- Neutral white light (4000°K)
- Emission angle: 120°
- Power supply: 10...30Vdc or 24Vdc (22...30Vdc)
- Wiring output: side (**Opt.** "UP": rear)
- Cable length: 30 cm
- Light intensity: 540 lux at 1 m (610 or 680 lux)
- Protection class: IP50 (IP 54 with **Opt.** S2, or IP65 with **Opt.** S5)
- Protected against power surges
- Wall mount, 2 brackets supplied (AV0490)
- Length: 240 mm (400 or 640 mm)
- Weight: ~ 180 g (210g or 340g)

#### Applications



Code	Description	QM
LSE124KW40	Led lamp for technical rooms, wall mount, 10...30Vdc, 7W, 540lux, NW, 240 x 45 x 11 mm	1
LSE140GW40	Led lamp for technical rooms, wall mount, 24Vdc, 14W, 610lux, NW, 400 x 45 x 11 mm	1 
LSE164GW40	Led lamp for technical rooms, wall mount, 24Vdc, 21W, 680lux, NW, 640 x 45 x 11 mm	1
S2	<b>Opt.</b> – Protection class IP54	10
S5	<b>Opt.</b> – Protection class IP65	
UP	<b>Opt.</b> – Rear wiring output	5
AV0490	<b>Acc.</b> – Kit 2 plastic mounting brackets, 12 x 33mm (one kit supplied with each lamp)	10

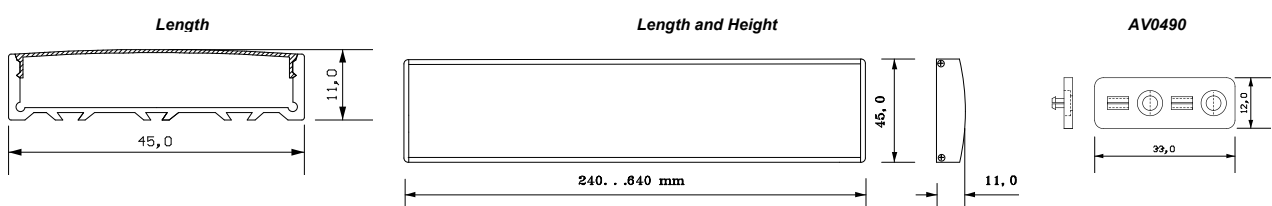



## RUMBA, Led lamp for technical rooms, recessed

Designed to replace halogen or neon lamps. Elegant white anodized aluminium structure, suitable for lighting engine rooms or technical rooms, for small or large boats. Spring fixing system for walls or ceilings. Intense and uniform illumination with a wide emission angle and a neutral white light. They do not heat up and do not suffer from vibrations. The low voltage power supply also allows for use in emergency circuits.

### Technical specifications

- Aluminium casing
- Lamp colour: white, RAL 9003
- Opaline filter
- Power consumption: 20W (24W)
- Neutral white light: 4000°K
- Emission angle: 90°
- Power supply: 24 Vdc (22...30Vdc)
- Power supply wires output: side
- Cable length: from 50 cm
- Light intensity: 495 Lux at 1 m (opaline filter)
- Protection class: IP50 (IP54 with **Opt. "S2"**)
- Protected against power surges
- Flush mounting
- Dimensions: 600 x 67 x 62 mm
- Weight: ~ 850 g

### Application



Code	Description	QM
<b>LRU160GW40</b>	LED lamp for technical rooms, built-in, 24 Vdc (22...30Vdc), neutral white light (20W)	1
<b>LRU160GW40-E</b>	LED lamp for technical rooms, built-in, 24 Vdc (22...30Vdc), neutral white light (24W), with emergency	1
<b>LRU160AW40</b>	LED lamp for technical rooms, built-in, 200...240 Vac, neutral white light (20W), with emergency	1
<b>LRU160AW40-E</b>	LED lamp for technical rooms, built-in, 200...240 Vacc, neutral white light (24W), with emergency	1
<b>S2</b>	<b>Opt.</b> – IP54 protection treatment	10

Spring fastening system

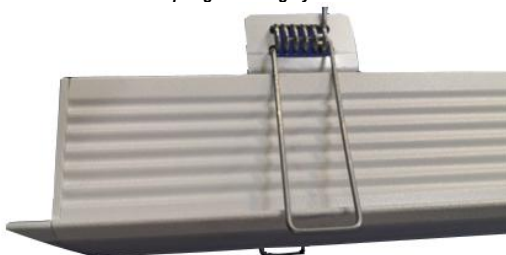

Dimensions

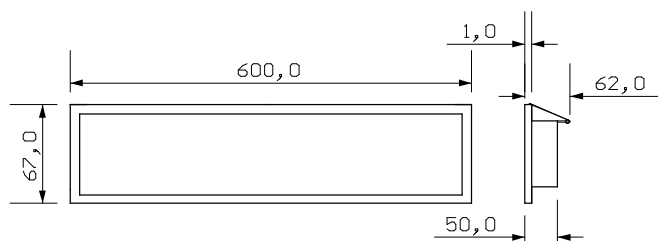

Recess fitting LED lamps, for technical rooms, also with emergency circuit



### SAMBA, Led lamp for engine rooms and technical areas, also available with emergency lighting

Designed to replace fluorescent tube lamps. Elegant white metal frame, suitable for lighting engine rooms on medium and large vessels. Flush mounting, suitable for lowered or slatted ceilings. Intense and uniform neutral white light with a wide emission angle. Resistant to humidity and vibrations. Equipped for double lighting circuit, total, partial and emergency.

#### Technical specifications

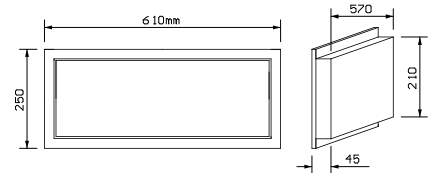

- Painted white metal casing (RAL 9003)
- 4mm satin finish filter
- Low power consumption: 16W (at 24 Vdc)
- Neutral white light (4500°K)
- Emission angle: 120°
- Power supply: 24 Vdc or 100...240 Vac (with internal power supply)
- Light intensity: 420 Lux at 1 m
- Protection class IP50 (IP 54 with **Opt. S2**, or IP65 with **Opt. S5**)
- Protected against power surges
- Recess mounting, screw fix (A), cable passage (B)
- Dimensions: 61 x 25 x 57 x 21 x 4,5
- Weight: ~ 2600 g (DC), 2700 g (AC)

#### Dimensions

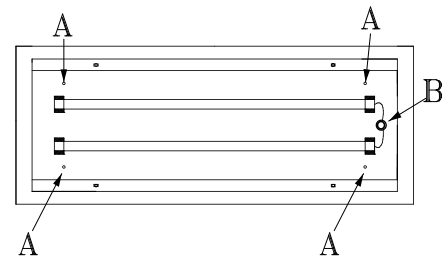

#### Internal view, DC



Code	Description	QM
<b>LSM61GW50</b>	SAMBA, single power supply, 24Vdc (16W), neutral white light (16W), IP50	1
<b>LSM61AW50</b>	SAMBA, single power supply, 100...240 Vac (16W), neutral white light, IP50	1
<b>LSM61AW50-E</b>	SAMBA, dual power supply, 100...240 Vac (16W), 24Vdc (3 W) with emergency light, neutral white light, IP50	1
<b>LSI151GW40</b>	SIBILLA, replacement bulb for LSM61GW50, 24Vdc (8W), neutral white light, IP50	1
<b>S2</b>	<b>Opt.</b> – Protection class IP54 	10
<b>S5</b>	<b>Opt.</b> – Protection class IP65 	10

#### Applications



#### Internal view, AC, with emergency light

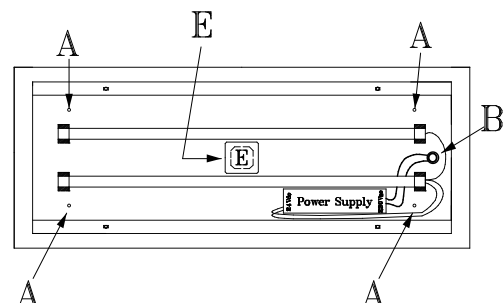

Led lamp, wall mount, for hazardous areas, zones 2 (gas), 22 (dust)



### Applications



### ATEX, Led lamp for hazardous areas, zones 2 (gas), 22 (dust)

Waterproof led lamp in aluminium alloy, suitable for use in potentially explosive atmospheres as defined in ATEX 2014/34/EU. The body of the lamp is anti-corrosive and finished with a non-toxic, heat resistant anti-scratch polyester paint. The body colour is RAL 7035 grey, the diffuser is in prismatic tempered glass. The steel wire protective cage is RAL 2011 orange and is attached to the body by means of stainless steel screws, the seal is guaranteed by a reinforced gasket in anti-ageing elastomer. Supplied with an M20 input cable gland, complete with internal and external ground screws. Suitable for use in garages and engine rooms.

#### Technical specifications

- Aluminium alloy body
- Tempered glass filter
- Body colour: RAL 7035 grey
- Protective cage colour: RAL 2011 orange
- Emission angle: 120°
- Neutral white light (4000°K)
- Power supply: 12 o 24 Vdc
- Protection class: IP65
- Operating temperature: -20...+40°C
- Cable section max: 1.5 mm<sup>2</sup>
- Light intensity: 170 lux at 1 m
- Protected against power surges and polarity inversion
- Standard: EN60079-14
- Power consumption: 6 W
- Weight: ~ 830 g

#### Dimensions

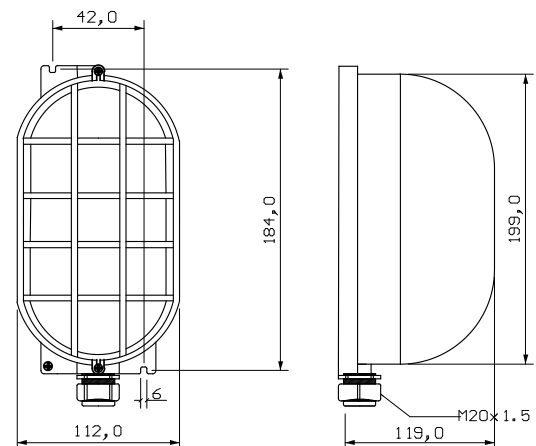

Code	Description	QM
LAX120FW40	ATEX, Led lamp, wall mount, ATEX compliant, neutral white light, 12 Vdc power supply (zones 2, 22)	1
LAX120GW40	ATEX, Led lamp, wall mount, ATEX compliant, neutral white light, 24 Vdc power supply (zones 2, 22)	1
LAX201152EX	2 pole switch, 16 A 250 V, ATEX compliant, external dimensions 94 x 145 x 54 mm (ESA)	1
LAX312FW40	Led bulb, without case for turtle ceiling light (Tecla/Atex), neutral white light, 12 Vdc, 120 x 65 mm	10
LAX312GW40	Led bulb, without case for turtle ceiling light (Tecla/Atex), neutral white light, 24 Vdc, 120 x 65 mm	10

#### CONFORMITY TO STANDARDS

ATEX 2014/34/EU



#### ATEX COMPLIANT

IIC 3G 3D - IP65



**FIAMMA, portable Led work lamp for difficult areas, protection class IP65**

New compact design, easy to hold and bright light. Robust polycarbonate casing. Intense and uniform lighting with a wide emission angle. Designed for use in difficult areas such as: boatsheds, engine rooms, lift shafts and for work on lorries, vans, campervans, etc. The lower power consumption means it is ideal for use in emergencies.

**Technical specifications**

- Emission angle 120°
- Neutral white light (4000°K)
- Opaline diffuser
- Shock-proof polycarbonate case
- Power consumption: 10 W
- Power supply: 24 Vdc (also available 12 Vdc)
- Protection class: IP65
- Brightness: 1300 lumen
- Light intensity: 210 lux at 1 m.
- Hanging hook: adjustable, plastic
- Power cable: extendable up to 5 mt.
- Dimensions: Ø 25/33 x 520 mm
- Weight: ~ 280 g.

**Dimensions**



Code	Description	QM	AV0423
LFM555FW	FIAMMA, Portable Led lamp, power supply 12 Vdc, with power cable extendable to 5m	10	
LFM555GW	FIAMMA, Portable Led lamp, power supply 24 Vdc, with power cable extendable to 5m	1	
AV0423	Acc. - Pair of fixing clasps (supplied with each lamp)	5	

**Dimensions**



**Pair of fixing clasps**

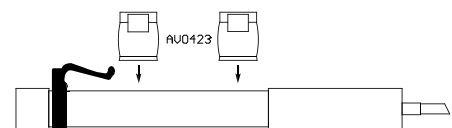

# SPOT 25, 29

## LED wall spotlights and G4/GU5.3 bulbs



Spot 25



Spot 29



### SPOT 25, Led wall mount lamp, IP67/65 protection

Essential and minimal in size, very thin. Suitable for classic and modern environments, designed for use in boats, lifts, pits and engine compartments or for lighting cabinets, galleys, bathrooms. Simple and quick to install, the low consumption makes them ideal for use in emergency systems.

#### Technical specifications

- Light source: Led
- Casing material: polycarbonate
- Finish: satin with transparent border
- Emission angle: 120°
- Light: neutral 4000°K (or warm 3000°K)
- Power supply: 12...30 Vdc
- Mounting: wall/ceiling
- Fixing: screw (TC Ø 2,9 x 16 mm, not included)
- Protection class: IP67 front, IP65 rear
- Light intensity: 55 lux at 1 m
- Protected against power surges, no polarity
- Power consumption: 2,5 W
- Weight: ~ 15 g.

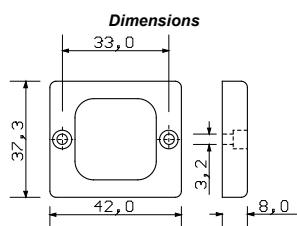

### SPOT 29, high efficiency replacement Led bulb

They replace 15/20 W halogen bulbs with a consumption of only 2.5 W, and an operating life ten times longer. They emit a pleasant warm white light (very similar to that of halogen) spread evenly in the environment thanks to the wide emission angle.

#### Technical specifications

- Light source: Led
- Emission angle: 120°
- Light: warm white 3000 K
- Power supply: 12 V (12...14 Vdc) or 24 V (22...26 Vdc)
- Connector: central G4/GU5.3 (convertible into lateral)
- Light intensity: 60 lux at 1 m
- Free of UV rays
- Operating life: 30.000 hours @ 25°C
- Operating temperature: -10...+40°C
- Protected against power surges, no polarity
- Power consumption: 2,5 W
- Dimmer: PWM in voltage (ACD004)
- Weight: ~ 1 g.

**Dimensions**

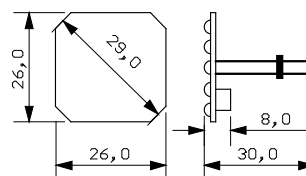

Code	Description	QM
<b>LSP25FKW40</b>	SPOT 25, Led wall mount lamp, 12...30 Vdc, 2,5W, neutral white light, 20 cm cable	10
<b>LSP29CFW30</b>	SPOT 29, Replacement Led, central/lateral G4/GU5.3 connector, 12... 14 Vdc, warm white light, dimmable	10
<b>LSP29CGW30</b>	SPOT 29, Replacement Led, central/lateral G4/GU5.3 connector, 22...26 Vdc, warm white light, dimmable	10

Spot 29 – Central and lateral GU5.3 connector

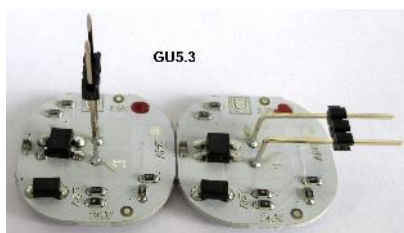

Spot 29 – Central and lateral G4 connector

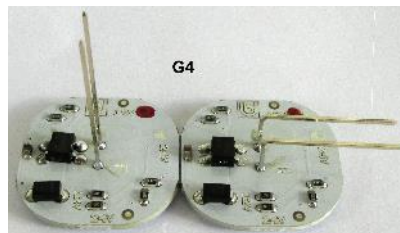

# SPOT 50, MR16

Led recess mount lamp and GU5.3 base lamp

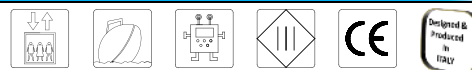

Spot 50



Spot 50 with Opz. M



Spring clip AV0466



## SPOT 50, Led lamp, 50 mm diameter, for indoor and outdoor use

High level of protection and efficiency. Replacements for 15/20 W halogen lamps with a consumption of only 2,5 W and an operating life of at least 10 times longer. They emit a pleasant warm, white light with a wide, uniform emission angle. Suitable for exteriors (Opt. S).

### Technical specifications

- Diameter: 50mm, cable length 20 cm
- Power consumption: 2,5 W
- Power supply: 12...30 Vdc (not dimmable)
- Power supply: 12...14 Vdc (dimmable with ACD004)
- Power supply: 22...26 Vdc (dimmable with ACD004)
- Light: neutral 4000°K or warm 3000°K
- Emission angle: 120°
- Protection class: IP40 (IP65 **Opt. S**)
- Light intensity: 50 lux at 1 m
- Without polarity, protected against power surges
- Cut-out: Ø 44 mm
- Weight: ~ 25 g.

### Dimensions

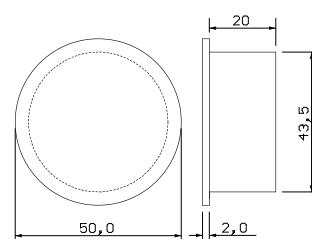

Code	Description	QM
LSP50FFW30	SPOT 50, Led lamp, neutral white light, 12... 14 Vdc (dimmable)	10
LSP50FGW30	SPOT 50, Led lamp, neutral white light, 22...26 Vdc (dimmable)	10
LSP50FKW40	SPOT 50, Led lamp, neutral white light, 12...30Vdc (not dimmable)	10
S	Opt. - IP65 class exterior protection cap ( <b>not compatible with Opt M</b> )	1
M	Opt – Fitted with stainless steel spring clips for recess mount	10
AV0466	Acc. – Kit: 2 stainless steel spring fixing clips	10



## SPOT MR16, Led lamp, 50mm diameter, GU5.3 base connector

Highly efficient Led lamp. The same size as 20 W dichroic halogen lamps but with a power consumption of only 2,5W and ten times more operating life. Warm white light with a wide, uniform emission angle.

### Technical specifications

- Diameter: 50 mm
- Base: GU5.3
- Power consumption: 3 W
- Power supply: 12...30 Vdc (not dimmable)
- Light: neutral 4000°K or warm 3000°K
- Emission angle: 120°
- Light intensity: 55 lux at 1 m
- Without polarity, protected against power surges
- Weight: ~ 25 g.

### Dimensions

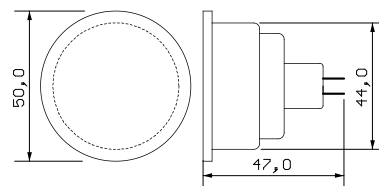

Code	Description	QM
LSPM16FW30	SPOT MR16, led lamp, GU5,3 base, warm white light, 12...14 Vdc (dimmable wit ACD004)	10
LSPM16GW30	SPOT MR16, led lamp, GU5,3 base, warm white light, 12...14 Vdc (dimmable wit ACD004)	10
LSPM16KW40	SPOT MR16, led lamp, GU5,3 base, neutral white light, 12...30 Vdc (not dimmable)	10

## Night sky, pre-wired lighting system

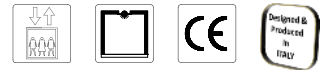

### “Night sky” effect pre-wired lighting system

This lighting system allows designers to implement an economical and easy to install, customized “night sky” effect. The pre-wired connection systems makes for quick and easy installation and maintenance in lift cars. For lighting compliant with safety regulations, it is usually necessary to allow for 20 to 30 “Stelle” per square meter, depending on the surface area to be covered and the materials used in construction.

#### STELLE

LCS2KW40 LCS3KW40

The “Stelle” are the Led lights which allow designers to install “night skies” with multiple effects. Installation is extremely easy. Each light can be inserted into a 12 mm hole and secured by the hex nut supplied. Dimensions Ø 12 or 18 x 12 x 26 mm. Power supply 10...30 Vdc. 50 cm cable with plug connector. Power consumption 0,5 W at 12 Vdc. Polycarbonate case. Neutral white light, 4000°K. Light intensity 15 lux at 1 m. Thread 12 MA x 1,5. Protection class IP67 front, IP40 rear. Weight: ~ 8 g.



#### CONCENTRATOR

LCS3000

Controller with 1 input (from the power supply) and 10 outputs for powering 10 “Stelle”. Dimensions 85 x 50 x 32 mm (H). Connecting cable to power supply 1.5 m. Weight: ~ 90 g.



#### POWER SUPPLY for pre-wired system

AV0495

Designed to supply a maximum of 2 controllers (LCS3000) and 20 “Stelle”. Input: 200...240 Vac - Output: 12 Vdc, 20 W. Mounting: wall. Weight: ~ 80 g.



#### POWER SUPPLY for pre-wired system, with battery check and charge

AV0481

Designed to power up to 3 controllers (LCS3000) and 30 “Stelle” (LCS3KW40). Input 200...240 Vac, output 12 Vdc, 20 W. Connection for 35mm DIN rail or for wall mounting. Internal control and charge circuit for an external 12 Vdc battery (AV0476). In the absence of mains voltage, the emergency circuit is automatically activated, drawing power directly from the rechargeable battery, providing an autonomy of over 3 hours at a maximum load of 2 W. Weight: ~ 125 g.



#### EMERGENCY MODULE for 12Vdc Led lamps

AV0502

Suitable for loads up to a maximum of 5 A (60W), it has a control and charging circuit for an external 12 Vdc battery. Primary power supply: 230 Vac - 50 Hz – Output voltage (Vout): 12 Vdc – 1,25 A. Emergency voltage: 12,5...13,8 Vdc – Maximum output load: 5 A (60W), protected by fuse. Nominal emergency operating time: 3 hours with a 2 W load with AV0476 battery



#### BATTERY

AV0476

Rechargeable backup battery, AGM, air-tight, lead, 12 Vdc, 1,3 Ah. Faston terminals (4,8 mm). - Dimensions: 98 x 42 x 58 mm (H). Weight: ~ 600 g.



#### Sample connection “Night Sky” with battery charger

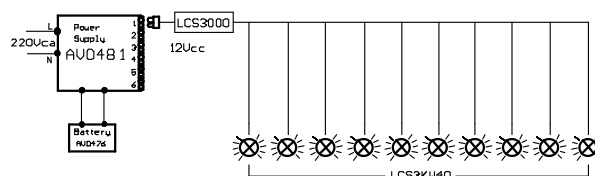



**PICO, digital panel meters, red, green, blue or white Led 3 digit-display**

The PICO line is made of a range of digital indicators with a 13mm three-digit red, green, blue or white display. Reliable and accurate. Made for installation in control panels. They are particularly appreciated for the speed of installation and the excellent ratio between the size of the digits and the overall dimensions.

**Technical specifications**

- Reading point: 999 digit
- Display: 3 digit, 13 mm red Leds (green, blue or white on request – **Opt.**)
- Input in tension, current, temperature, level and pressure
- Polarity: automatic, only minus sign (-) with Led (polarity)
- Decimal point: programmable (Dp 1)
- Overrange indication: with Led
- Power supply: 10...30 Vdc / Vac
- Connections: screws, on removable terminal block (sect. max 2.5 mm<sup>2</sup>)
- Power consumption: 1,8 VA max
- Front protection class: IP54
- Dimensions: 24 (L) x 55 (H) x 53 mm (P)
- Weight: ~ 60 g (DC)

**Dimensions**

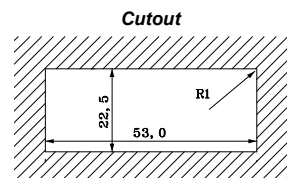
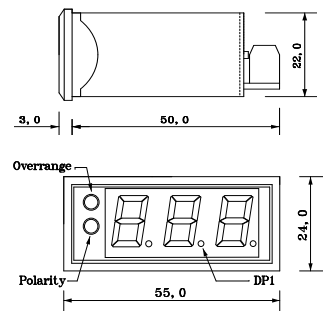

Code	Function	Notes	Accuracy
1510-K	PICO, Voltmeter -999...+999 mVdc	Suitable also for current measures via shunt (100A/100 mV) isolated power supply	0,5%
1513-T	PICO, Voltmeter 0...100 Vdc	Direct measurement	0,5%
1524-T	PICO, Voltmeter 0...250 Vac (complete with TV AV0223)	With TV	1%
1535-K	PICO, Ammeter for SHUNT 60 mV	With Shunt from 10/15/25/50/60 or multiples	0,5%
1545-T	PICO, Ammeter for CT / 5A	With CT from 50/100/150/250	1%
1569-T	PICO, Thermometer 0...99.9°C	For use only with AV0361 probe	0,5%
1580-T	PICO, Process signals 0...10 V - 0/4...20 mA	Programmable to 0 and FS	0,5%
1588-K	PICO, Level/pressure signal for probes 0/10...180 Ω	Programmable to 0 and FS	1%
1589-K	PICO, Level/pressure signal for probes 240...33 Ω	Programmable to 0 and FS	1%

Code	Description	Code	Description
AV0223	Acc. – Transformer 240/24 Vac	K	Opt. - Power supply 10...30 Vdc, isolated
AV0385	Acc. - Transformer 115 / 24 Vac	45D	Opt. – Green display
AV0365	Acc. - Enlarging adaptor 36 x 72mm (DIN 43700)	45F	Opt. – Blue display
AV0361	Acc. - Temperature probe 0...100°C, with 1.5 m cable	45W	Opt. – White display, darkened casing
T	Power supply standard 10...30 Vdc, not isolated	47B	Opt. – Reduced luminosity (Day 100%, Night 30%)



Applications



### FAST, digital panel meter, red Led 3,5 digit display

Integration, precision, robustness, functionality and high quality are the main features of this line of panel meters, long adopted by panel fitters. Also available with a relay alarm threshold (option).

#### Technical specifications

- Reading point: 1999 digit
- Display: 3,5 digit, 14,2 mm red Leds
- Input in tension, current, temperature, process, frequency
- Polarity: automatic, only minus sign (-)
- Decimal point: programmable from front panel
- Reading update: 2,5 per second
- Overrange indication: "1" positive, "-1" negative
- Power supply: DC or AC
- Relay alarm output (**Opt. "31"**)
- Power consumption: 4 VA
- Conversion technique: dual slope integration
- Connections: screws, on removable terminal block, sect. max 2,5 mm<sup>2</sup>
- Dimensions: 36 x 72 x 81 mm, DIN 43700
- Front protection: IP40
- Weight: ~ 200 g. (DC)

#### Dimensions

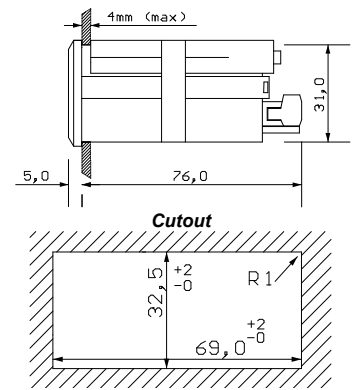

Code	Function	Notes	Accuracy
3402-A	FAST, Process signals 4...20 mA	Configurable reading 0...FS	0,3%
3403-A	FAST, Customised Adc / Vdc process signals	Configurable reading 0...FS	0,3%
3404-A	FAST, Process signals 0...20 mA	Configurable reading 0...FS	0,3%
3407-A	FAST, Process signals 0...10 Vdc	Configurable reading 0...FS	0,3%
3410-A	FAST, DC voltmeter $\pm 1999$ mV – F.S.	---	0,2%
3411-A	FAST, DC voltmeter $\pm 199,9$ mV – F.S.	Direct measure or via Shunt type 100A / 100 mV	0,2%
3412-A	FAST, DC voltmeter $\pm 19,99$ V – F.S.	---	0,2%
3413-A	FAST, DC voltmeter $\pm 199,9$ V – F.S.	---	0,2%
3414-A	FAST, DC voltmeter $\pm 500$ V – F.S.	---	0,2%
3422-A	FAST, AC voltmeter 0...19,99V	---	0,5%
3423-A	FAST, AC voltmeter 0...199,9V	---	0,5%
3424-A	FAST, AC voltmeter 0...500V	---	0,5%
3433-A	FAST, DC ammeter $\pm 199,9$ mA	---	0,3%
3434-A	FAST, DC ammeter $\pm 1,999$ A	---	0,3%
3435-A	FAST, DC ammeter 0...60 mV	For shunt with ratio of 5, 6, 10, 15, 20, 25 and multiples	0,3%
3445-A	FAST, AC ammeter 0...5 A	For CT with ratio of 5, 6, 10, 15, 20, 25 and multiples	0,5%
3466-A	FAST, Thermometer PT100 - -100...199,9°C	Temperature measured via 3-wire PT100 sensor	0,5%
3467-A	FAST, Thermometer PT100 - -100...650°C	Temperature measured via 3-wire PT100 sensor	0,5%
3485-A	FAST, Frequency meter / Tachometer	Measures mains line frequency or rpm's via NPN/PNP sensors (Power supply 5 Vdc)	0,3%

Code	Description	Code	Description
A	Standard power supply 230 Vac, 50/60 Hz	10	Opt. - Custom configuration/setup
B	Opt. - Power supply 110 Vac, $\pm 10\%$ - 50/60 Hz	31	Opt. - One relay alarm output
C	Opt. - Power supply 24 Vac, 50/60 Hz	47A	Opt. - Brightness reduction (Thursday 100%, Night 50%)
H	Opt. - Power supply 10...40 Vdc, isolated	47B	Opt. - Rid. luminosità (Gio 100%, Not.30%)

## Digital panel meter, 3.5 digit display

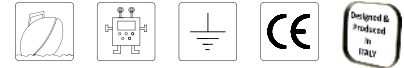

### METER, digital panel meter, red Led 3.5 digit-display

Integration, precision, robustness, functionality and high quality are the main features of this line of panel meters, long adopted by panel fitters on plants and test benches. Wide range of options and configurations (some of which can be done on site). Inputs for process signals, voltage or direct current, alternating current (TRMS), temperature, frequency, revolutions, load cells, resistance.

#### Technical specifications

- Display: 3.5 digit, 14,2 mm red Leds
- Polarity: automatic, only minus sign (-)
- Decimal point: programmable from front panel
- Reading update: 2.5 per second
- Overrange indication: "1" positive, "-1" negative
- Relay alarm outputs (**Opt. 21, 22, 23**)
- Power consumption: 4 VA
- Conversion technique: dual slope integration
- Connections: screws, on removable terminal block, sect. max 2,5 mm<sup>2</sup>
- Dimensions: 48 x 96 x 112 mm, DIN 43700, black polycarbonate
- Front protection class: IP40
- Weight: ~ 350 g. (DC)

#### Dimensions

A=Filter, B=Slide mounts, C=Terminal block, D=Fixing screw

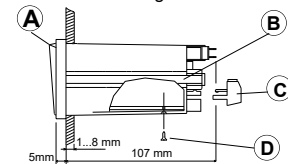

#### Cutout

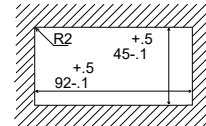

Code	Function	Notes	Accuracy
4403-S	METER, Customised mAdc/Vdc process signals	Configurable reading 0...FS	0,1%
4410-S	METER, DC voltmeter $\pm 1999$ mV – F.S.		0,1%
4411-S	METER, DC voltmeter $\pm 199,9$ mV – F.S.		0,1%
4412-S	METER, DC voltmeter $\pm 19,99$ V – F.S.		0,1%
4413-S	METER, DC voltmeter $\pm 199,9$ V – F.S.		0,1%
4414-S	METER, DC voltmeter $\pm 500$ V – F.S.		0,1%
4421-S	METER, AC voltmeter 0...1,999 V		0,2%
4422-S	METER, AC voltmeter 0...19,99 V		0,2%
4423-S	METER, AC voltmeter 0...199,9 V		0,2%
4424-S	METER, AC voltmeter 0...500 V		0,2%
4426-S	METER, TRMS voltmeter 0...1,999 V	F = 20...2000Hz (Sin) - $\pm 1\%$ DC+AC Crest Factor. $\leq 6$	$\pm 0,2\%$
4427-S	METER, TRMS voltmeter 0...19,99 V	F = 20...2000Hz (Sin) - $\pm 1\%$ DC+AC Crest Factor. $\leq 6$	$\pm 0,2\%$
4428-S	METER, TRMS voltmeter 0...199,9 V	F = 20...2000Hz (Sin) - $\pm 1\%$ DC+AC Crest Factor. $\leq 6$	$\pm 0,2\%$
4429-S	METER, TRMS voltmeter 0...500 V	F = 20...2000Hz (Sin) - $\pm 1\%$ DC+AC Crest Factor. $\leq 6$	$\pm 0,2\%$
4433-S	METER, DC ammeter $\pm 199,9$ mA		0,2%
4434-S	METER, DC ammeter $\pm 1,999$ A		0,2%
4435-S	METER, DC ammeter 0...60 mV	Shunt ratio 4, 5, 6, 8, 10, 15, 20, 25 and multiples	0,2%
4443-S	METER, AC ammeter 0...199,9 mA		0,5%
4444-S	METER, AC ammeter 0...1,999 A		0,5%
4445-S	METER, AC ammeter 0...5 A	CT ratio 5, 6, 10, 15, 20, 25, 40, 80 and multiples	0,5%
4447-S	METER, TRMS Ammeter 0...199,9 mA	F = 20...2000Hz (Sin) - $\pm 1\%$ DC+AC Crest Factor. $\leq 6$	$\pm 0,5\%$
4448-S	METER, TRMS Ammeter 0...1,999 A	F = 20...2000Hz (Sin) - $\pm 1\%$ DC+AC Crest Factor. $\leq 6$	$\pm 0,5\%$
4449-S	METER, TRMS Ammeter 0...5 A	F = 20...2000Hz (Sin) - $\pm 1\%$ DC+AC Crest Factor. $\leq 6$	$\pm 0,5\%$
4468-S	METER, PT100 thermometer via 3-wire sensor	3 scale -100,0+...199,9°C, -100+...650°C, -328+...1562°F	0,5%
4470-S	METER, Ohmmeter	4 scale - 0...199,9 $\Omega$ , 0...1,999 k $\Omega$ , 0...19,99 k $\Omega$ , 0...199,9 k $\Omega$	0,2%
4480-S	METER, Standard process signals	0+5V, 1+5V, 0+10V, 0+20 mA, 4+20 mA, configurable reading	0,1%
4482-S	METER, Signals from potentiometer via 3-wire sensor	Nominal value range 0,5...50 k $\Omega$	0,1%
4484-S	METER, Signals from load cells	Value range 0,5...3,5 mV/V, cell power supply 10 V $\pm 4\%$ 35mA	0,1%
4485-S	METER, Frequency meter/Tachometer	Measures via NPN/PNP sensors, sensor power supply 5V (15V)	0,2%
Code	Description	Code	Description
<b>S</b>	Standard power supply 90...270 Vac, 50/60 Hz	<b>25/26</b>	<b>Opt.</b> - Analog output 1mV/digit, 0...10V
<b>K</b>	<b>Opt.</b> - Power supply 10...30 Vdc / Vac	<b>27</b>	<b>Opt.</b> - Analog output 4...20mA
<b>10</b>	<b>Opt.</b> - Custom configuration/setup	<b>48</b>	<b>Opt.</b> - Dummy zero display
<b>21/22</b>	<b>Opt.</b> - 1/2 relay alarm output	<b>82</b>	<b>Opt.</b> - 15Vdc output voltage for sensors (only mod 4485)

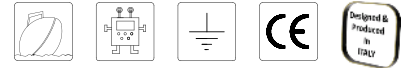

### MICRO 94, digital panel meter, programmable red Led 4,5 digit-display

The MICRO-94 digital panel meter is microprocessor based, with 20,000 reading points. Functions can be programmed easily and intuitively from the front of the panel to display peak, hold and tare values. Programmable reading means the meter is particularly suitable for all applications where the signal must be presented with multiplication or division ratios.

#### Technical specifications

- Display: 4,5 digit, 14,2 mm red Led
- Parameter programming: front keyboard
- Automatic polarity, only minus sign
- Reading update: 12,5 per second
- Overrange indication: "OFL" positive, "-OFL" negative
- Display update: from 1:1 to 1:100
- AC or DC power supplies
- Sensor power supply: 24 Vdc  $\pm 4\%$  - 30 mA
- Relay alarm outputs (programmable hysteresis 0...999 digits, delay 0...9 seconds)
- Analog outputs (Opt. 59 / 60 / 61)
- Digital outputs (Opt. 69)
- Power consumption: 4 VA
- Connections: screws, on removable terminal block, sect. max 2,5 mm<sup>2</sup>
- Dimensions: 48 x 96 x 112 mm, DIN 43700, black polycarbonate casing
- Front protection class: IP40
- Weight: ~ 400 g. (DC)

#### Dimensions

A=Filter, B=Slide mounts, C=Terminal block, D=Fixing screw

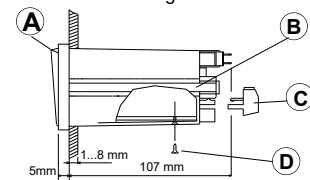

#### Cutout

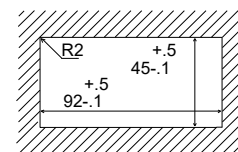

Code	Function	Notes	Accuracy
9410-S	DC voltmeter, -1,9999...+1,9999 V	Programmable reading, full scale $\pm 19999$ , zero $\pm 19999$	$\pm 0,05\%$
9412-S	DC voltmeter, -19,999...+19,999 V	Programmable reading, full scale $\pm 19999$ , zero $\pm 19999$	$\pm 0,05\%$
9413-S	DC voltmeter, -199,99...+199,99 V	Programmable reading, full scale $\pm 19999$ , zero $\pm 19999$	$\pm 0,05\%$
9414-S	DC voltmeter, -500,0...+500,0 V	Programmable reading, full scale $\pm 19999$ , zero $\pm 19999$	$\pm 0,05\%$
9421-S	AC voltmeter, 0...1,9999 V	---	0,2%
9422-S	AC voltmeter, 0...19,999 V	---	0,2%
9423-S	AC voltmeter, 0...199,99 V	---	0,2%
9424-S	AC voltmeter, 0...500,0 V	---	0,2%
9426-S	TRMS voltmeter, 0...1,9999 V	F = 20...2000 Hz (Sin.) $\pm 1\%$ DC+AC Crest Factor $\leq 6$	$\pm 0,2\%$
9427-S	TRMS voltmeter, 0...19,999 V	F = 20...2000 Hz (Sin.) $\pm 1\%$ DC+AC Crest Factor $\leq 6$	$\pm 0,2\%$
9428-S	TRMS voltmeter, 0...199,99 V	F = 20...2000 Hz (Sin.) $\pm 1\%$ DC+AC Crest Factor $\leq 6$	$\pm 0,2\%$
9429-S	TRMS voltmeter, 0...500,0 V	F = 20...2000 Hz (Sin.) $\pm 1\%$ DC+AC Crest Factor $\leq 6$	$\pm 0,2\%$
9433-S	DC ammeter	Readings: -199,99...+199,99 mA	0,2%
9434-S	DC ammeter	Readings: -1,9999...+1,9999 A	0,2%
9435-S	DC ammeter via shunt 0...60 mV	Ratios 6, 10, 20, 25, 60, 100, 150, 250, 400, 600 or multiples	0,2%
9443-S	AC ammeter 0...199,99 mA	---	0,5%
9444-S	AC ammeter 0...1,9999 A	---	0,5%
9445-S	Ammeter via CT 0...5 A	---	0,5%
9447-S	TRMS ammeter, 0...199,99 mA	F = 20...2000 Hz (Sin.) $\pm 1\%$ DC+AC Crest Factor $\leq 6$	$\pm 0,5\%$
9448-S	TRMS ammeter, 0...1,9999 A	F = 20...2000 Hz (Sin.) $\pm 1\%$ DC+AC Crest Factor $\leq 6$	$\pm 0,5\%$
9449-S	TRMS ammeter, CT 0...5 A	F = 20...2000 Hz (Sin.) $\pm 1\%$ DC+AC Crest Factor $\leq 6$	$\pm 0,5\%$
9468-S	3-wire PT100 thermometer (3 scale)	-100,00...+199,99 / -100,0...+650,0 / -328,0...+1562,0 °F	0,5%
9470-S	4-wire Ohmmeter (4 scale)	0+199,99 $\Omega$ / 0+1,9999 k $\Omega$ / 0+19,999 k $\Omega$ / 0+199,99 k $\Omega$	0,2%
9480-S	Process signals 0+5,1+5,0+10V,0+20mA, 4+20mA	Programmable reading, full scale $\pm 19999$ , zero $\pm 19999$	$\pm 0,1\%$
9482-S	Linear potentiometer signals	Nominal value in range 0,5+50 k $\Omega$	0,1%
9484-S	Signals from load cells, value range 0,5...3,5 mV/V	Cell power supply 10V $\pm 4\%$ 35 mA	0,1%
9485-S	Frequency meter/Tachometer	Measures via NPN/PNP sensors, sensor power supply 5V	0,2%
Code	Description	Code	Description
S	Standard power supply 90...270 Vac	60	Opt. - Analog outputs 0...5V, 1...5V, 0...10mA
K	Opt. - Power supply 10...30 Vdc / Vac	61	Opt. - Analog outputs -5...+5V, -3...+5V
10	Opt. - Custom configuration/setup	69	Opt. - RS232 serial interface
59	Opt. - Analog outputs 0...10V/0...4...20mA	82	Opt. - 15Vdc output for sensors (only mod 9485)

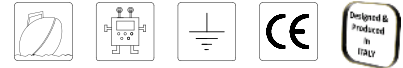

## MICRO 9215, multifunction 5 digit display

**Tachometer**, this instrument calculates the speed value based on the frequency of the impulses coming from the external sensor (proximity, pick-up, etc.).

Impulses per revolution: 1-255 - Decimal point: 0, 1, 2, auto - Measurement update: 0.1, 0.25, 0.5, 1, 2, 4, 8 seconds.  
Unit of measurement conversion.

**Frequency meter**, the instrument calculates the value of the input frequency of the pulses coming from the external sensor (proximity, pick-up, etc.). This value can also be converted in order to the desired unit of measurement.

Decimal point: 0, 1, 2, auto - Unit of measurement conversion, Reset, Hold.  
Unit of measurement conversion.

**Totalisation**, the pulses from the external sensor (proximity, pick-up, etc.) are totalised.

Through the measurement conversion it is possible to make the each pulse correspond to desired increment.

Decimal point: 0, 1, 2, auto - Unit of measurement conversion, Reset, Hold.

Memory: the count remains stored for 10 years, even in the absence of power supply.

**Timer**, when the "SIGNAL" input is closed, the timer counts the time until the input is returned to the open condition.

Scale: 10 minutes, 10 hours, 1000 hours. Unit of measurement conversion, Reset, Hold.

Memory: the count remains stored for 10 years, even in the absence of power supply

### Common technical specifications

- Display: 5 digit 13mm Led
- Accuracy:  $\pm 0.005\% \pm 1$  digit (overrange signal)
- Sensors: Optical probe, Proximity, Pick-up, Contact sensor, encoder, etc.
- Power supply to sensors: 12Vdc/30mA or 5Vdc/30mA
- Wave form of input: sinusoidal min 100mVpp (a 1KHz), max 50Vac, square or open-collector (low = 0-1.5V high = 4-30V)
- Input impedance (pick-up): 18K (signal): 2K $\Omega$
- Maximum frequency: in tachometer, frequency and totalisation 30KHz
- Two fully programmable alarm relays, maximum contact current: 1A at 125 Vac (resistive load), maximum switchable power 50VA
- Analog output: 0...10V e 4...20mA not isolated (**Opt.** 72)
- Power supply: AC or DC
- Connections: screws, on removable terminal block
- Dimensions: 48 x 96 x 112 mm, DIN 43700, black polycarbonate casing
- Front protection class: IP40
- Weight: ~ 400 g. (DC)

### Dimensions

A=Filter, B=Slide mounts, C=Terminal block, D=Fixing screw

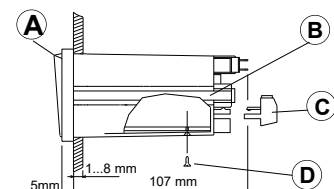

### Cutout

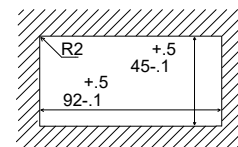

Code	Description	Code	Description
9215-S	Digital panel meter, 110...240Vac	10	Opt. – Custom configuration/setup
K	Opt. – Power supply 9...36 Vdc	72	Opt. – Analog output 0...10 and 4...20mA



Pulsar



### PULSAR, 5 digit digital rpm indicators, for dashboard

This indicator has been designed for detecting the number of revolutions by proximity with the application of a single notch on the moving shaft. It is ideal for measuring the rpm of engines in the automation and marine sectors.

#### Technical specifications

- Reading points: 99999
- Display: 5 digits, 13 mm red Led
- Accuracy:  $\pm 0,1$  rev/min
- Input waveform: square or open-collector – low=0-1.5V – high=4-30V
- Input impedance: 2K $\Omega$
- Temperature stability: 75 ppm (typ.) 100 ppm (max)
- Time base: one second quartz scan
- Standard power supply: 230 Vac (50...60Hz) and 9...28 Vdc
- Connection: screws on removable terminal block, sect. max 2,5 mm<sup>2</sup>
- Decimal point: activated/disactivated from terminal
- Display brightness: dimmable from terminal
- Operating temperature: 0...+45°C
- Sensor power supply: 5Vdc/30mA
- Casing: black polycarbonate
- Dimensions: 48 x 96 x 105 (112) mm
- Front protection class: IP40 - Weight: ~ 330 g

#### Dimensions

A=Filter, B=Slide mounts, C=Terminal block, D=Fixing

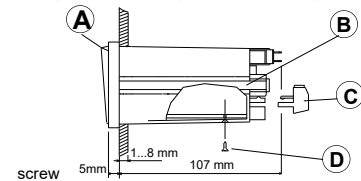

#### Cutout

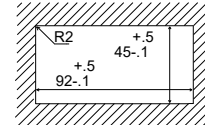

Code	Description
<b>9011-A</b>	Tachometer, 5 digits, 1 pulse per rotation via proximity sensor, standard power supply 230 Vac and 9...28Vdc
<b>AV0157</b>	Acc. Proximity - sensor to detect number of revolutions per minute

RPM



### Portable optical and contact tachometer

Digital tachometer for measuring angular and linear velocity. The optical model is suitable for applications where the instrument cannot have physical contact with the moving object or must avoid any braking effect; the contact model uses rubber and roller tips for contact with the moving part. Its compact size, shock resistant case and easy operation makes this tachometer ideal for all industrial and marine environments.

#### Technical specifications

- Optical or contact monitoring of rpm
- Complete set of accessories and carrying case
- Can be combined with external probes (models 8406 and 8455)
- Totalisation function (models 8406 and 8455)
- Display-hold of last measured value
- Reading points: 19999 or 99999
- Display: 4 digit or 5 digit, 7,6 mm red Led, ultra-bright
- Stability:  $\pm 0,015\%$  /°C max
- Optical working distance ranges: 10...300 mm
- Power supply: 4 x 1,5V AA batteries supplied
- Autonomy: ~ 20 hours - Low battery warning
- Optical dimensions: 65 (A) x 180 mm (B), black ABS
- Contact dimensions: 65 (A) x 215 mm (B), black ABS
- Weight: ~ 400 g (including batteries)

#### Dimensions

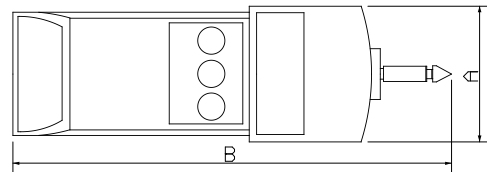

Code	Function	Notes	Accuracy
<b>8404</b>	Optical tachometer 2...19000 rpm (ESA)	With carrying case and set of reflectors	$\pm 0,1$ rpm up to 999,9 rpm and
<b>8406</b>	Optical tachometer 2...100000 rpm	With carrying case, set of reflectors and connector for external probes	
<b>8433</b>	Contact tachometer 2...19000 rpm, 0,02...2000,0 m/min (ESA)	With carrying case and rubber tip set	$\pm 0,005\%$ above 1000 rpm
<b>8440</b>	Contact tach. 2...19000 rpm, 0,02...2000,0 m/min, 0,01...2000,0 m/s (ESA)	With carrying case and rubber tip set	
<b>8455</b>	Contact tachometer 0,2...30000 rpm, 0,02...2000,0 m/min	With carrying case, rubber tip set and connector for external probes	
<b>AV0158</b>	Acc. – Set of reflectors 25 x 90 mm	<b>AV0160</b> Acc. – Wheel for linear measurement, 20mm shaft	
<b>AV0159</b>	Acc. – Rubber tip set	<b>AV0501</b> Acc. – Proximity, sensor for portable use only	

### SGR15



### Applications

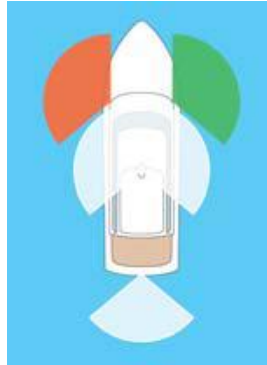

### SGR20



**GRILLO SGR15** is an electronic device with 5 independent channels that controls the correct operation of the navigation lights of a boat.

The device allows you to check the operating status of the bulbs both of the traditional type (filament) and in Led technology, powered with voltages of 12 or 24 Vdc.

Thanks to the front Leds and the voltage outputs, it provides an immediate and simple verification by signaling the possible conditions for each lamp.

Compact dimensions container for DIN rail mounting.

**GRILLO SGR20** is an electronic device with 5 independent channels that controls the correct operation of the navigation lights of a boat.

The device allows you to check the operating status of the bulbs both of the traditional type (filament) and in Led technology, powered with voltages of 12 or 24 Vdc.

Thanks to the front Leds and the voltage outputs, it provides an immediate and simple verification by signaling the possible conditions for each lamp.

The SGR20 stores the current value of the individual channels and highlights any anomalies if the measured value is less than about 30% of the set tolerance range (useful for recognizing the aging of the connected lamp).

#### The operating states detected are:

**Green** = Working (lamp on)

**Yellow** = Short circuit (lamp off)

**Red** = Interrupted (lamp off)

#### Technical specifications

- Increases safety on board
- Provides clear and rapid verification of the status of lights
- For Led and filament lamps
- Suitable for 1...25W (12 V) and 1...50W (24 V)
- Maximum current per channel: 2 Adc
- Five channels (lights) per module
- Independent alarm output for each channel
- Power supply: powered by the line of the lamps
- Electrical connections: screw (max sect. 2,5 mm<sup>2</sup>)
- Mounting: 35 mm DIN rail
- Operating temperature: 0...60°C
- Installation overvoltage category: II°
- Safety and pollution requirements rating: 2 (CEI EN61010-1)
- Dimensions: 100 (A) x 120 (B) x 22,5mm (C)
- Weight: ~ 150g

#### The operating states detected are:

**Green** = Channel working, current in the initial range, lamp on.

**Blue** = Channel in alarm, open circuit, voltage but no current in the channel, bulb damaged or not connected.

**Red** = Channel in alarm, short circuit.

**Off** = Channel not used.

**Violet** = Channel in fault.

**ON-STATUS** = Green, everything OK. Red, channel malfunction.

#### Technical specifications

- Power supply: 12/24 Vdc, consumption 50mA
- Power range: Min 0,3 W - Max 10 W (12/24V)
- Maximum current per channel: 2 A at 12Vdc (1A to 24Vdc)
- Short circuit protection:  $\geq 2,5$  Acc
- Overvoltage protection:  $\geq 36$  Vcc
- Open circuit intervention threshold:  $\leq 20$  mAdc
- Electrical connections: screws (max sect. 2,5 mm<sup>2</sup>)
- Mounting: 35 mm DIN rail
- Operating temperature: 0...60°C
- Installation overvoltage category: II°
- Safety and pollution requirements rating: 2 (CEI EN61010-1)
- Dimensions: 100 (A) x 120 (B) x 22,5mm (C)
- Weight: ~ 150 g

Code	Description
<b>SGR15</b>	GRILLO 15, Navigation light controller for conventional and Led lamps, with 5 channels
<b>SGR20</b>	GRILLO 20, Navigation light controller for Led lamps, 5 channels, with memorization of the life of the lamps.

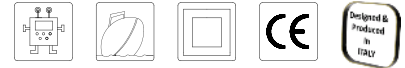

### Applications

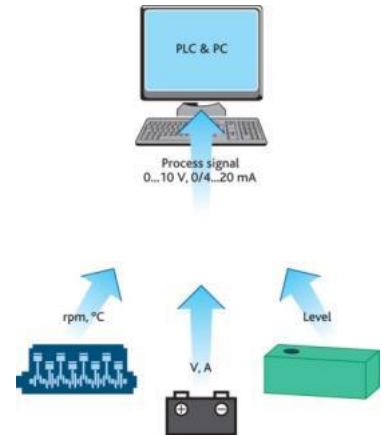

### Analog signal converter/transmitter

Range of transmitters/converters for analog signals in voltages, current, frequency and resistance (useful for measuring levels, temperatures, etc.). Galvanic separation between input, output and power supply. SMT technology and single feed in both DC and AC. Three programmable outputs (0...10 V, 0 / 4...20 mA), equipped with two trimmers for fine tuning the retransmitted signal (zero and span). Front Led informs of power presence.

#### Technical specifications

- Accuracy (at 20°C):  $\pm 1\%$
- Linearity and repetition: 0,25% typical
- Temperature coefficient:  $\leq 0,05\%/^{\circ}\text{C}$
- Response time: 300 ms
- Voltage output (load  $\geq 100\text{ K}\Omega$ ): 0...10 V
- Current output (load  $\leq 500\ \Omega$ ): 0 / 4...20 mA
- Power supply: 10...30 Vdc / Vac (2 W - VA)
- Galvanic insulation in/out/power supply: 2,3 KVac
- Insulation resistance in/out/power supply:  $\geq 100\ \text{M}\Omega$
- Electrical connections: screw
- Weight: ~ 150 g.

#### Dimensions

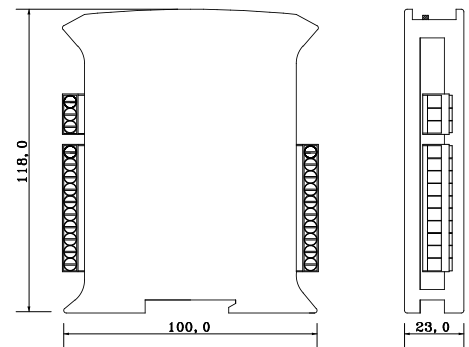

Code	Description	Function	
731035-K	Tx73, DC voltage/current, 0...15 V, 0...30 V, 0...60 mV (via shunt)	Suitable for converting power supply line signals from batteries	
732045-K	Tx73, AC voltage/current, 0...150 V, 0...300 V, 0...5 A direct or from CT	Suitable for converting power supply line signals from mains network	
732400-K	Tx73, AC voltage 0...500 V	Suitable for converting power supply line signals from 380 V lines	
736600-K	Tx73, Temperature, 0...50°C, 100°C, 200°C	Converts the signal from a PT100 resistance thermometer	
736700-K	Tx73, Temperature, 0...200°C, 400°C, 800°C	Converts the signal from a PT100 resistance thermometer	
738000-K	Tx73, Process signals, 0+10 V, 0+20 mA, 4+20mA	Converts and isolates a normalised signal into another	
738200-K	Tx73, Signals from potentiometer 1...50 K $\Omega$	Converts a signal from a linear potentiometer	
738500-K	Tx73, Frequency/revolutions 20, 200, 2000, 20000 Hz	Measures the network frequency or number of revolutions through pick ups, proximity switches, optical probes and NPN/PNP sensors. It has a sensor power supply (5 Vdc)	
738700-K	Tx73, Level 60/90...0,5/3 $\Omega$	Converts and isolates signals from tubular level probes (VDO compatible)	
738800-K	Tx73, Level, pressure 0/3/10...180 $\Omega$	Converts and isolates signals from pressure sensors (VDO compatible), level probes or sensors 0/10...180 $\Omega$	
738900-K	Tx73, Level 240...33 $\Omega$	Converts and isolates signals from float level probes (Teleflex, Vetus and S.Giorgio SEIN compatible)	
739100-K	Tx73, Universal, DC and AC, 0+15/30 Vdc, 0+60 mVdc 0+150/300 Vac, 0+5 Aac	Universal model that combines all the characteristics of models 731035 and 732045	
Code	Description	Code	Description
K	Standard power supply 10...30 Vdc/ac – isolated	10	Opt.– Custom configuration/setup input and output



RPL105

RPL106 / 118



### BINDINO, intelligent bilge switch, flood prevention sensor

Intelligent electronic switches for bilge pumps and flood water pumps. They monitor the presence of water and activate the suction pump. They automatically adjust their operating parameters based on the type of liquid present, ensuring operation with any water mixture. Can be powered with any voltage between 10 and 30 Vdc. A status Led shows the working conditions.

#### Technical specifications

- Micriprocessor technology
- Power consumption: min 0,4 W (relay at rest), 0,9 W (relay activated)
- Adapts to any water mixture
- No moving parts subject to mechanical blocks
- Avoids false pumping
- Protection class: IP68
- With IMQ certification (Italian Mark of Quality)
- Power supply: 10...30 Vdc
- Max. relay load RPL105 and RPL106: 16 A (N.A. type SPST)
- Max. relay load RPL118: 1 A
- Activation delay: approx. 10 sec.
- Disconnection delay: approx. 30 sec.
- Operating temperature: 0...60°C
- Weight: ~ 250 g (with 1 m cable)

#### Applications

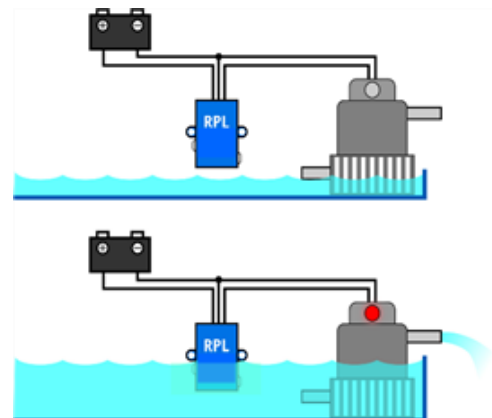

Code	Description	QM
RPL105	BINDINO, Intelligent bilge pump switch, 16A relay	5
RPL106	BINDINO, Intelligent bilge pump switch with contact plates, 16A relay	5
RPL118	BINDINO, Flood prevention sensor with contact plates, 1A relay	5

RPL105

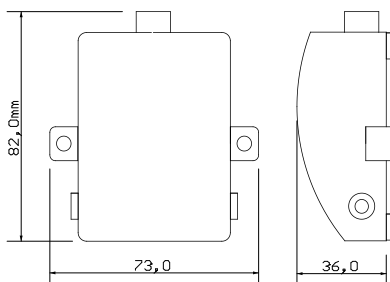

RPL106 and RPL118

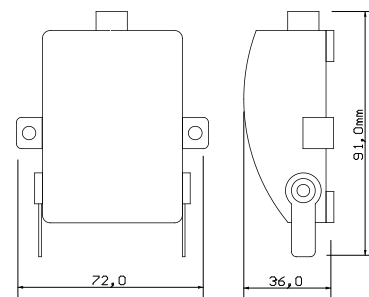

## Dimmer, luminosity changer, driver



Block diagram

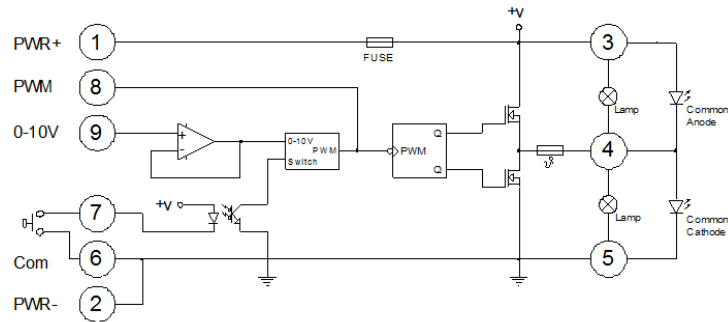

### Dimmer, luminosity changer for Led lamps or filament bulbs

Electronic device to control the intensity of classic incandescent or Led Lamps, resistive or electronic, with PWM-TTL input. The dimming is driven by external buttons or analog signal 0÷10 V. Can be controlled by N.A. (SPST) type button. The dimmer regulates the light intensity from any of the switching points on the electrical circuit and memorises the last selected function. It is equipped with a slow "Soft-start" function which prevents disturbances and damage to connected equipment. It can also operate as Master/Slave. There are 2 Led indicators: green, to show that the device is powered and red, to signal interruption of the internal fuse.

#### Technical specifications

- Regulation of light intensity: 5...100%
- For use with Led, incandescent, resistive o electronic lamps (PWM-TTL)
- Mosfet power output: 100 W (12V), 200 W (24V)
- Can be configured as Master / Slave
- Buttons: single pole-single via momentary (SPST)
- Use with live signal: 0...10 V
- Power supply: 10...30 Vdc
- Max. current: 10 A
- Power consumption: 30 mAdc max
- Internal fuse (replaceable)
- Plastic casing, protection class: IP20
- Mounting: 35 mm DIN bar
- Operating temperature: 0...+50°C
- Dimensions: 90 x 35 x 58 mm (2 DIN modules)
- Weight: ~ 100 g.

#### Lamp connection (default)

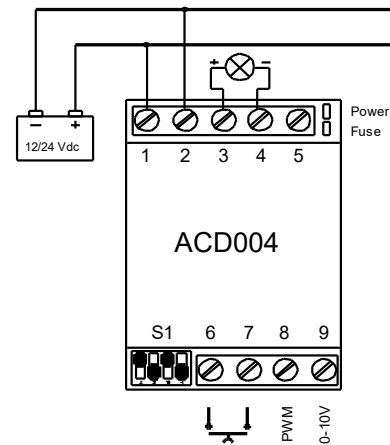

Code	Description	QM
<b>ACD004</b>	DIMMER, Electronic luminosity changer, for loads up to 100W at 12 Vdc (200W at 24Vdc), standard	1

### DRIVER for Led, protection class IP68

1-channel Led driver, for controlling direct current Leds. With power supplies between 9 and 36 Vdc it provides a constant current of 350 or 400 mA suitable for driving power Leds for lighting. Designed for harsh environments, it is particularly suitable for the marine industry, as it is water and humidity resistant with IP68 protection. Weight: ~ 25 g.



Code	Description	QM
<b>ACD110</b>	Acc. - Driver for Led 350 mA, dia. 18 x 49mm (Mini red light)	5
<b>ACD115</b>	Acc. - Driver for Led 400 mA, dia. 18 x 49mm (Mini white light)	5



### Device control panel (also with opto-isolated commands)

Equipped with 6 relays to activate/deactivate devices using 10...30 Vdc power supply. The circuit board is supplied with two input connectors, the first (removable screw connector) for controlling outputs through external buttons, the second (flat cable connector) for controlling the panel by way of a dedicated keyboard. The relay contacts in exchange (NC C NO) are independently connected to the terminals so that it is possible to vary the supply source to each device connected; each output is also protected by a fuse (similar to automotive fuses) mounted on a dedicated PCB fuse board (to facilitate replacements). The maximum current available for each output is 10 A constant and 16 A momentary. Each output is operated independently by a micro-controller which, according to the position of the first 6 dip-switches (present on the circuit board), allows the operating mode of the relative output to be set either as momentary or constant. To avoid accidental simultaneous activation of outputs, which could damage the device connected, the interlockage between outputs can be programmed (max. 4) via contacts 7 and 8 of the same dip-switch.

#### Technical specifications

- Power supply: 10...30Vdc
- Number of channels: 6 independent
- Two types of command: button or dedicated keyboard
- Relay output: exchange
- Two models: 6 DC channels or 5 DC + 1 AC
- Max. load: 10 A constant
- Protection: 10° fuses, on each output
- I/O connector for PLC interface
- Interlocks: 4 configurable
- Operating temperature: from - 30°C to +50°C
- Mounting: 35 mm DIN rail
- Weight: ~ 270 g.

#### Dimensions

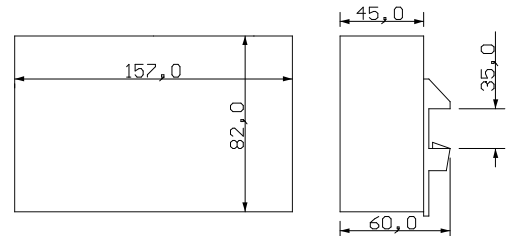

Code	Description	QM
ACD015-K	Device control panel, relay, 5 DC channels, 1 AC channel, power supply 10...30 Vdc, 10 A fuse (ESA)	1
ACD016-K	Device control panel, relay, 6 DC channels, power supply 10...30 Vdc, 10 A fuse (ESA)	1
ACD018-K	Device control panel, relay, 6 DC channels, power supply 10...30 Vdc, 10 A fuse, with opto-isolated commands	1
05	Opt. 5 A fuse	10
AV0406-F	Device control panel, relay, 6 channels, power supply 12 Vdc, 10 A (ESA)	1
AV0406-G	Device control panel, relay, 6 channels, power supply 24 Vdc, 10 A (ESA)	1

#### Configuration of the ACD015/16 control panel and interlocks

**Example:** Bit 7 OFF, Bit 8 ON = block channels 1...6, when channel 1 is active channel 6 cannot be activated and vice versa

ON	OFF	SW1 - PREDISPOSTORE / PRECONDITION
■	□	8 bit 7 ON bit 8 ON : nessun blocco - not block
■	■	7 bit 7 OFF bit 8 ON : blocco 1/6 - block 1/6
■	□	6 bit 7 ON bit 8 OFF : blocco 2/5 - block 2/5
■	■	5 bit 7 OFF bit 8 OFF : blocco 3/4 - block 3/4
■	□	4 bit 1 ÷ 6
■	■	3 ON : bistabile (interruttore) - switch
■	□	2 OFF : monostabile (pulsante) - pushbutton

#### View of the dip-switch (SW1)



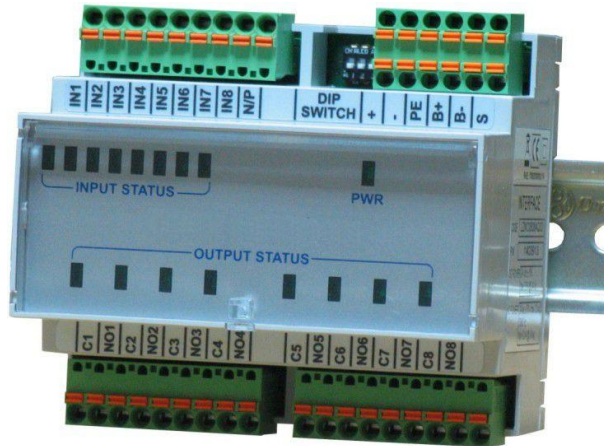

### 3.0 - GENERAL DESCRIPTION

#### The rear panel interface has:

- n. 8 configurable digital inputs, all NPN or all PNP
  - applicable voltage : 10...30 Vdc
  - impedance : 4700 Ω
- n. 8 green leds indicating "active input"
- n. 8 relay outputs
  - SPST 5A/250Vac contact; 5A/30Vdc
  - Independent common contacts
- n. 8 green leds indicating "active output"
- n. 1 porta seriale MODBUS RTU (RS485):
  - baud rate : 300...38400
  - address : 1...247
  - parity : none, even, odd
- n. 1 green led indicating "power"

#### Principali caratteristiche

- **Casing:** Modular DIN EN 50022 rail enclosure, compliant with DIN 43880, 6 modules (105mm), Weight 300g, Depth 68 mm, Protection class IP20
- **Power supply:** 24Vdc o 24Vac ±15%
- **Resistive load:** 5A 250Vac / 30Vdc
- **Serial port:** Physical layer RS485
- **Communication protocol:** MODBUS RTU
- **Maximum switching voltage:** 400Vac / 125Vdc
- **Maximum switching current:** 6A
- **Networkable units:** 127
- **Room temperature:** -10...50°C
- **Dimensions:** 105 (L) x 82 (P) x 68mm (H)

#### Front View

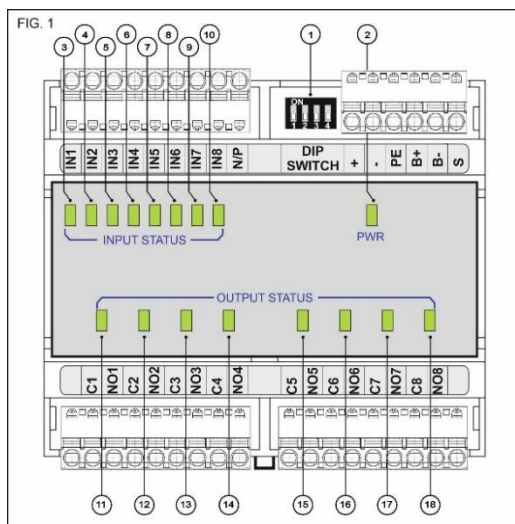

#### Collegamenti

- 1 = Dip-switch for programming device
- 2 = green led PWR: indicates the presence of supply voltage
- 3 = green led: indicates the position of input 1
- 4 = green led: indicates the position of input 2
- 5 = green led: indicates the position of input 3
- 6 = green led: indicates the position of input 4
- 7 = green led: indicates the position of input 5
- 8 = green led: indicates the position of input 6
- 9 = green led: indicates the position of input 7
- 10 = green led: indicates the position of input 8
- 11 = green led: indicates activation of output 1
- 12 = green led: indicates activation of output 2
- 13 = green led: indicates activation of output 3
- 14 = green led: indicates activation of output 4
- 15 = green led: indicates activation of output 5
- 16 = green led: indicates activation of output 6
- 17 = green led: indicates activation of output 7
- 18 = Green led indicates activation of output 8

Code Descrizione

**ACD030-Z** Relay control unit, 8 opto inputs, 8 relay outputs, 1 ModBus RTU serial port, 24Vdc/ac ± 15% power supply



## 24/12Vdc Step-Down Reducer and AC Line Protector

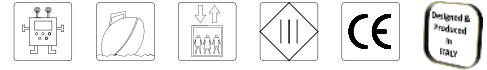

Set up diagram

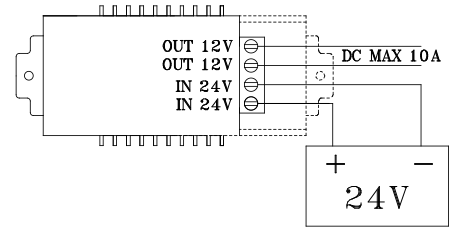

### AV0499, 24/12 Step-Down Reducer

Designed to power 12V LED appliances and/or lamps, when a 24V voltage is available. The DC output voltage is constant and stabilized at any amperage.

#### Technical specifications

- Power supply: 24 Vdc
- No load power consumption: 20 mA
- Operating temperature range: -40...+80°C
- Protected against short circuits
- Max output amperage: 10A
- Protected against power surges
- Dimensions: 102 x 47 x 30 mm
- Weight: 90g

#### Dimensions

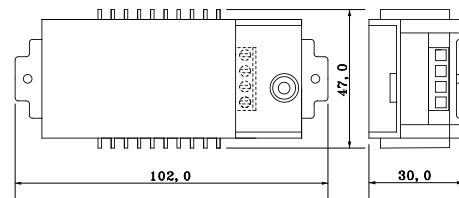

Code	Description	QM
AV0499	24/12 Vdc Step-Down Reducer, 10A max	5



Set up diagram

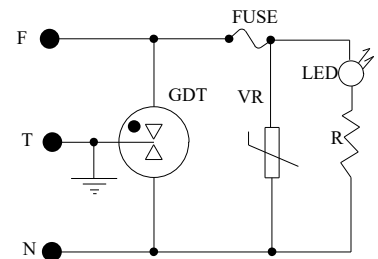

### AV0500, CA/AC Line Protector

The AV0500 is surge arrester, designed not only to protect Led lighting fixtures, but also for all electronic equipment exposed to power surges, such as digital indicators powered by mains voltage. It has double protection (Varistor + Gas discharger), effectively protects the drivers of Led lighting fixtures. Pre-wired with coloured conductors and of suitable cross section, it makes parallel installation simple. Can also be installed inside Led lamps. Visual Led status when the Varistor is on (red LED). Equipped with 3, 120 mm length wires, for easy connection to terminals.

#### Technical specifications

- Protection: also Led lighting fixtures
- Double protection: varistor + gas discharger
- Protection class: IP65
- Operating voltage: 500V RMS MAX 50/60 Hz
- Isolation: 1 GΩ at 100V
- Operating temperature range: -25...+70°C
- Impulse discharge: 20KA
- Dimensions: 50 x 40 x 14 mm
- Weight: 45 g

#### Dimensions

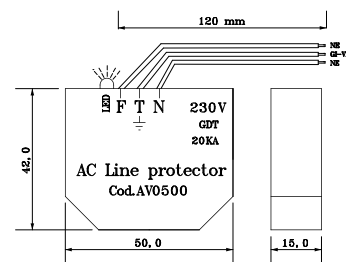

Codice	Descrizione	QM
AV0500	AC Line Protector	5

## Shunt and CT, current transformers

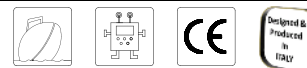

### Shunt

For measuring direct current.  
Output from 60mV or 100 mV

#### Technical specifications

- Highly accurate
- Nickel plated
- Made of manganin
- Mounted on isolated base for current up to 60 A
- Dissipation: 0,6 W/A
- Overload: 1,2 In continuous, 10 In (for 5") ≤ ASH250, 5 In for higher models
- Output in mV: on M4 screws with washers
- Input current: up to 60 A with M6 bolts, over 60 A with M10 bolts
- Note: on request productions from 1 to 6000 A

### CT, current transformers

Transformers for measuring alternating current.  
DIN rail. 5 A output.

#### Technical specifications

- Highly accurate
- Self-extinguishing thermoplastic case
- Wall fixing pins and snap-on 35mm DIN rail
- Dry isolation
- Integrated execution of the case and secondary cover
- Protection class of terminals: IP20, captive screws
- Input frequency: 50..60 Hz
- Nominal secondary current: 5 A
- Nominal short circuit current 100 In
- Max. insulation voltage: 0,6 KV
- Compliant with CEI standards and IEC recommendations

### Shunts and dimensions

Code	Capacity	Voltage drop	Class	Weight gr.	Fig.	A	B	C	D	F
ASH006	6 A	60 mV	0,5	104	1	23	-	78	123	27
ASH010	10 A	60 mV	0,5	106	1	23	-	78	123	27
ASH020	20 A	60 mV	0,5	107	1	23	-	78	123	27
ASH025	25 A	60 mV	0,5	108	1	23	-	78	123	27
ASH060	60 A	60 mV	0,5	130	1	23	-	78	123	27
ASH100	100 A	60 mV	0,5	235	2	10	36	86	112	25
ASH101	100 A	100 mV	0,5	235	2	10	36	114	138	25
ASH151	150 A	60 mV	0,5	240	2	10	38	86	112	25
ASH250	250 A	60 mV	0,5	245	2	10	38	86	112	25
ASH400	400 A	60 mV	0,5	354	2	10	40	86	117	38
ASH600	600 A	60 mV	0,5	1150	2	20	60	131	173	48

Fig. 1

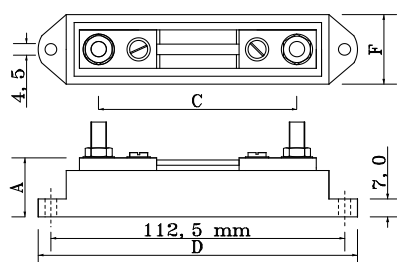

Fig. 2

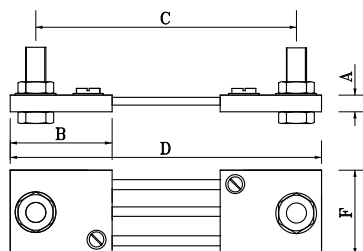
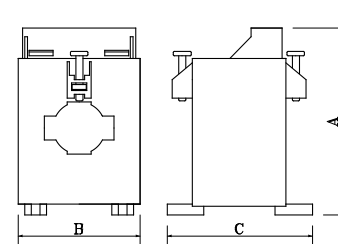

Fig. 3



### CT with Primary

Code	Primary	Secondary	Class	VA	Weight	Height (A)	Width (B)	Depth (C)
ATA020	20 A	5 A	0,5	5	300 g	57	84	70
ATA025	25 A	5 A	0,5	5	300 g	57	84	70
ATA050	50 A	5 A	0,5	5	300 g	57	84	70
ATA150	150 A	5 A	0,5	10	500 g	110	110	80

### CT for Bus bar (from 30 x 10 mm or diameter 22 mm), Fig. 3

Code	Primary	Secondary	Class	VA	Weight	Height (A)	Width (B)	Depth (C)
ATB050	50 A	5 A	1	1,5	260 g	86	56	66
ATB100	100 A	5 A	1	2	270 g	86	56	66
ATB150	150 A	5 A	1	2	280 g	86	56	66
ATB250	250 A	5 A	1	7	350 g	86	56	66

## Power supplies, battery chargers



### Power supplies for pre-wired systems

Designed to power a maximum of 6 spotlights (Spot, Punto, Zen) or one Mattonella. Wall mount.

Code	Description	Technical specifications	Protection
<b>AV0495</b>		<ul style="list-style-type: none"> <li>Plastic case</li> <li>Input: 200...240 Vac</li> <li>Output channels at 12 Vdc: 2 (AV0495), 4 (AV0480)</li> <li>Power: 20 W max</li> <li>Insulation class: II</li> <li>Connectors: screw terminal and connector</li> <li>Protection: overheating, over-voltage, overload</li> <li>Built to CE standards</li> <li>Mounting: screw (TC Ø 2,9 mm, not supplied)</li> <li>Output load: 1,25 A max.</li> <li>Weight: 80 g (2 outputs) – 90 g (4 outputs)</li> </ul>	
<b>AV0480</b>			IP20
<b>AV0495</b>	Power supply for pre-wired system, 2 12Vdc outputs. Dimensions 123 x 45 x 20 mm		IP20
<b>AV0480</b>	Power supply for pre-wired system, 4 12Vdc outputs. Dimensions 123 x 45 x 20 mm		IP20

### Power supply for pre-wired systems with control and charging circuit for external battery

Designed to power a maximum of 6 spotlights (Spot, Punto, Zen), one Mattonella or 30 Stella. Connection for 35mm DIN rail or for wall mounting. Complete with a control and charging circuit for an external 12 Vdc battery (AV0476). In the absence of mains voltage, it automatically activates the emergency circuit, drawing power directly from the rechargeable battery, ensuring an autonomy of over 3 hours at a maximum load of 2W.

Code	Description	Technical specifications	Protection
<b>AV0481</b>		<ul style="list-style-type: none"> <li>Plastic case</li> <li>Input: 200...240 Vac</li> <li>Output channels at 12 Vdc: 6</li> <li>Power: 20 W max</li> <li>Insulation class: II - Built to CE standards</li> <li>Connectors: screw terminal and connector</li> <li>Protection: overheating, over-voltage, overload</li> <li>Mounting: 35mm DIN rail or screw (not supplied)</li> <li>Output voltage for battery charger: 12,5...13,8 Vdc</li> <li>Output load: 0,5 A max, protected by self-resetting fuse</li> <li>Autonomy (12 Vdc – 1,3 AH battery): over 3 hours (max 2W)</li> <li>Weight: 125g</li> </ul>	
<b>AV0502</b>	12Vdc emergency lamp module, with automatic battery charger, max load 5A (60W) - Dim. 127(P) x 50(L) x 37(H)		IP20

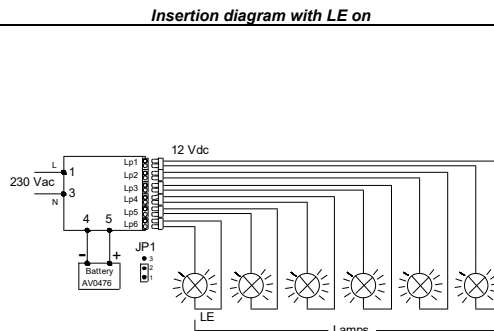

### Electronic power supply for Led lamps

A simple method to identify the appropriate power supply is to add the power of each individual light and then add at least 20% to the total.

Code	Description	Technical specifications	Protection	Weight g.
<b>AV0438</b>		<ul style="list-style-type: none"> <li>Casing: plastic (P) or metal (M)</li> <li>Input: 100...240 Vac - 50/60 Hz (see model)</li> <li>Output: 12 Vdc or 24 Vdc (see model)</li> <li>Power: 12...150 W, high performance</li> <li>Insulation class: II</li> <li>Connectors: screw terminals</li> <li>Protection: overheating, over-voltage, overload</li> <li>Built to CE and UL standards</li> </ul>		
<b>AV0479</b>	Power supply 200...240 Vac (IN), 12 Vdc (OUT), 15 W – Dimensions 123 (C) x 45 (B) x 20 mm (A)		IP20	60
<b>AV0442</b>	Power supply 100...240 Vac (IN), 12 Vdc (OUT), 20 W – Dimensions 115 (C) x 32 (B) x 25 mm (A)		IP67	220
<b>AV0438</b>	Power supply 100...240 Vac (IN), 12 Vdc (OUT), 25 W – Dimensions 90 (C) x 50 (B) x 28 mm (A)		IP20	190
<b>AV0440</b>	Power supply 100...240 Vac (IN), 12 Vdc (OUT), 75 W – Dimensions 150 (C) x 98 (B) x 38 mm (A)		IP20	245
<b>AV0441</b>	Power supply 100...240 Vac (IN), 12 Vdc (OUT), 150 W – Dimensions 200 (C) x 100 (B) x 38 mm (A)		IP20	670
<b>AV0489</b>	Power supply 200...240 Vac (IN), 24 Vdc (OUT), 15 W – Dimensions 101 (C) x 35 (B) x 16 mm (A)		IP20	70
<b>AV0477</b>	Power supply 100...240 Vac (IN), 24 Vdc (OUT), 25 W – Dimensions 90 (C) x 50 (B) x 28 mm (A)		IP20	195
<b>AV0473</b>	Power supply 100...240 Vac (IN), 24 Vdc (OUT), 35 W – Dimensions 146 (C) x 40 (B) x 30 mm (A)		IP67	330
<b>AV0483</b>	Power supply 100...240 Vac (IN), 24 Vdc (OUT), 75 W – Dimensions 150 (C) x 98 (B) x 38 mm (A)		IP20	240
<b>AV0484</b>	Power supply 100...240 Vac (IN), 24 Vdc (OUT), 150 W – Dimensions 170 (C) x 100 (B) x 38 mm (A)		IP20	430

# ACCESSORIES

For tachometers, batteries, adaptors, other

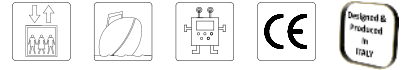

## Proximity

Magnetic proximity sensor to detect rotation speed by counting a notch (or notches) on the moving part.

- Measuring range: 0...100000 g/m
- Sensitivity: max 2 mm
- Operating temperature: 0...60°C
- Case: chromed brass M12 x 35 mm
- Cable length: 3 m – Weight 185 g

**Code AV0157 / AV0501**

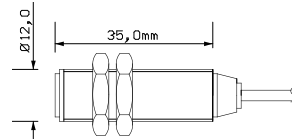

Note: AV0157 for panel tachometers - AV0501 for portable tachometers

## Reflector set

Adhesive strips of reflective material for use with portable optical tachometers (models 8404 and 8406).

- The kit includes 5 strips measuring 25 x 90 mm – Weight 5 g

**Code AV0158**

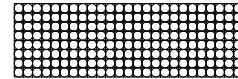

## Rubber tips set

Rubber tips for contact probes (AV0162) and portable contact tachometers. To be inserted onto metallic shaft (not provided) of models 8433, 8440 and 8455.

- Diameter 7mm – Weight 10 g

**Code AV0159**

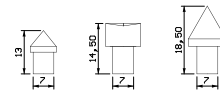

## Wheel for linear measurements

Wheels for linear speed measurements, for use with portable contact tachometers (models 8433, 8440 and 8455).

- Dimensions 5 (A) x 32 (B) x 8 (C) x 20 mm(D) – Weight 6 g

**Code AV0160**

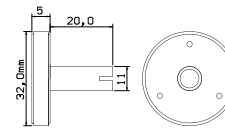

## Sealed AGM battery, rechargeable, Led

- Sealed AGM, rechargeable lead
- Output: 12 V – 1,3 Ah
- Terminals: Faston 4,8 mm
- Dimensions: 98 (C) x 42 (B) x 58 mm (C)
- Weight: ~ 600 g

**Code AV0476**



## Front adaptor for Pico

from 24x55 to 36x72mm (DIN 43700) - **Code AV0365** (Black) - Weight: 6 g

**Pair of cables**

**Code AV0486** (Black)

Weight: 18 g

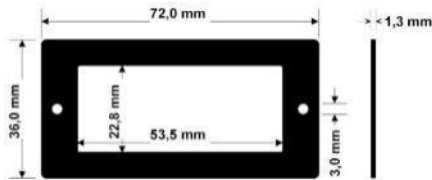

## Dust protector for Fast

**Code AV0306** (Transparent) - **Code AV0308** (Red)

Weight: 10 g

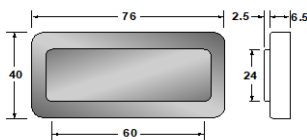

## Dust protector for Meter or Micro

**Code AV0307** (Transparent) - **Code AV0309** (Red)

Weight: 18 g

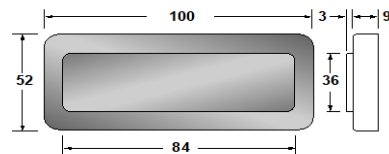

## Front adaptor for Meter or Micro

from 48x96 to 96x96 - **Code AV0312** (Black) - Weight: 14...16 g

## Front adaptor for Fast

from 36x72 to 48x96 - **Code AV0314** (Black) - Weight: 14 g

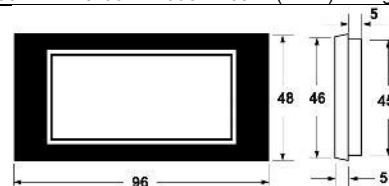
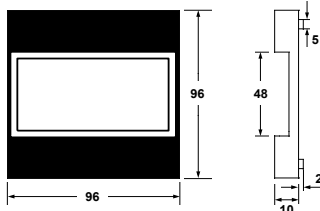

## Led strips, line protection, temperature probe

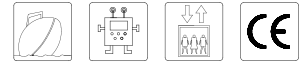

### Led strips, professional, 4,8 W/m., Protection class IP65, resinated

This range of products has been chosen and selected to ensure the perfect uniformity of colour of the emitted light, using professional Leds which ensure the characteristics over time (to be used with heat sink).



#### Technical specifications

- Roll, reel: 5000 x 10 x 4mm
- Illumination angle: 120°
- Operating temperature: -20...+50°C
- Photobiological risk: free
- Energy label: "A" - Adhesive: 3M – Weight 285 g (Roll)

#### Dimensions and composition

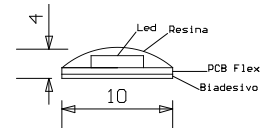

Code	Description	Colour temp.	Lumen	Cutting points	Led per mt.	Power supply
CS1070-F	Roll size 5000 x 10 x 4mm, warm white	3200/3500°K	260	5 cm	60	12 Vdc
CS1070-G	Roll size 5000 x 10 x 4mm, warm white	3200/3500°K	260	10 cm	60	24 Vdc
TL	Opz. - Customised length, registration of wires, on request					
AV0454	Acc. Line protection					

### Line protection, CC/DC

A bidirectional diode that offers high locking action and protection against power surges. The instantaneous response to transitory power surges makes it particularly suitable for protecting all sensitive low voltage devices such as integrated circuits, MOSFET, signal lines and Led lamps.



#### Technical specifications

- Peak power: 1500 W (10/1000us)
- Nominal breaking tension scale: 33 V
- Block tension and impulse peak max.: 45,7V-33A @ (10/1000us)
- Block tension and impulse peak max.: 59,0V-169A @ (8/20us)
- Bidirectional type with low attenuation factor
- Fast response time – Weight: 13 g (10 pieces)

#### Set-up diagram

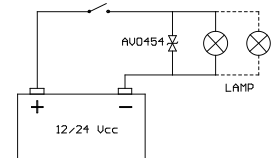

Code	Description	QM
AV0454	Acc. – Line protection	10

### PT100 Temperature probe - Code ATRLM1

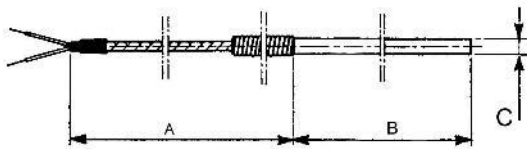

#### Technical specifications

- Range: -10...+400°C
- Sheath AISI 316
- EES cable = Electro-glass Silicone Shielded
- Type: 3 wires – Weight: 84 g
- Dimensions: A = 3000 – B = 100 – C = Ø 6mm

Note: Not suitable for humid environments

### PT100 Temperature probe - Code ATR210

External view



Dimensions

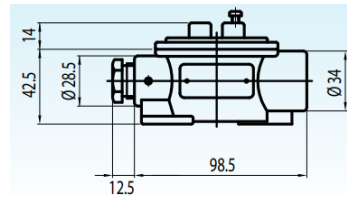

#### Technical specifications

- Range: 30...+130°C
- Aluminium case
- Wall mounting
- 4 wire connection
- Protection class: IP67
- Accuracy: EN60751 classes A, B
- Electrical connection: PG11
- Total dimensions: 180 x 70 x 57 mm
- Stelo sensore: Ø 6 x 60 mm
- Weight: 198 g

### LM35D Temperature probe with sensor - Code AV0361

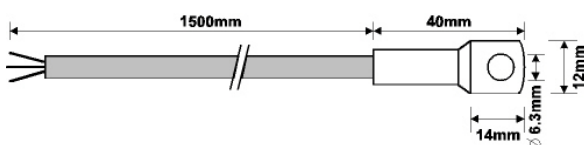

#### Technical specifications

- Range: 0...+100°C
  - Silicone cable
  - Type: 3 wires
  - Weight: 60 g
- Note: To be used with Pico 1569-T

# NEON STRIP LED

N.S.L. Professional



## NEON STRIP LED, professional

Led strips made with integrated silicone extrusion technology, protection class up to IP67 and characterized by excellent resistance to saline solutions, acids, corrosive gases, fire and UV.

Thanks to their resistance to atmospheric agents and torsion, these products are ideal for indoor and outdoor lighting, without imposing limits on the imagination of interior designers, architects and planners.

### Technical specifications – Code CS1310

- Standard power supply: 24 Vdc
- Power: 9,6 W mt
- Protection class IP67
- Light intensity: 670 per metre
- Reel length: from 5 mt
- Light: warm white 3000°K
- Curvature, minimum radius: 60mm
- Cutting line: 50 mm
- Operating temperature: from - 40°C to +70°C
- Emission angle: 118° (1m = 40 lx)
- Dimensions: 13x12x5000mm
- Weight: 940 g (roll)

### Technical specifications – Code 1311

- Standard power supply: 24 Vdc
- Power: 9,6 W mt
- Protection class IP67
- Light intensity: 520 per metre
- Reel length: from 5 mt
- Light: warm white 3000°K
- Curvature, minimum radius: 60mm
- Cutting line: 50 mm
- Operating temperature: from - 40°C to +70°C
- Emission angle: 118° (1m = 40 lx)
- Dimensions: 12x17x5000mm
- Weight: 960 g (roll)

### Technical specifications – Code 1326

- Standard power supply: 24 Vdc
- Power: 7.2 W mt
- Protection class IP65
- Light intensity: 300 per metre
- Reel length: from 5 mt
- Light: warm white 3000°K
- Curvature, minimum radius: 30mm
- Cutting line: 41.7 mm
- Operating temperature: from - 20°C to +45°C
- Emission angle: 118° (1m = 20 lx)
- Dimensions: 4x10x5000mm
- Weight: 375 g (roll)

Code	Description	QM
CS1310	NEON STRIP LED, 24Vdc, 9,6W, 3000°K, IP67, vertical light, vertical flex A and B, R >60mm (13x12)	1
CS1312	Acc. - Set of 5 caps with hole + 5 end caps, central cable outlet (13x12)	1
CS1316	Acc. - Set 10 fixing clips + 10 screws (13x12)	1
CS1311	NEON STRIP LED, 24Vdc, 9,6W, 3000°K, IP67, vertical light, horizontal flex A and B, R >60mm, (12x17)	1
CS1313	Acc. - Set of 5 caps with hole + 5 end caps, central cable outlet (12x17)	1
CS1315	Acc. - Set 10 fixing clips + 10 screws (12x17)	1
CS1326	NEON STRIP LED, 24Vdc, 7,2W, 3000°K, IP65, vertical light, horizontal flex A and B, R >30mm (4x10)	1
CS1327	Acc. - Set of 5 caps with hole + 5 end caps, central cable outlet (4x10)	1
TL	Opt. - Cut to size, wire header, on request	1

CS1310 – Vertical light, vertical flex (A...B)

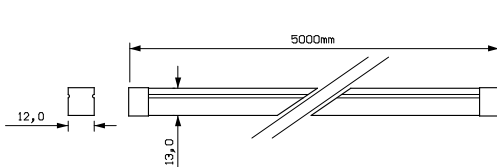

CS1311/CS1326h – Vertical light, horizontal flex (A...B)

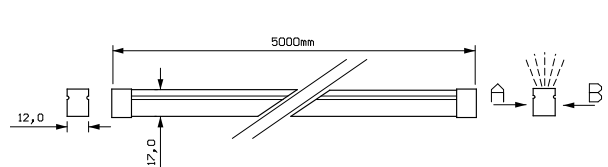

Fixing Clips

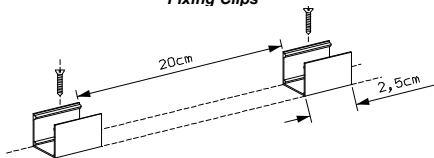

Cutting line

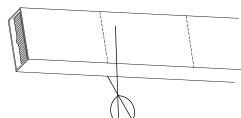

Caps

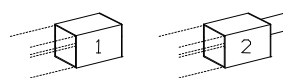

Minimum flex

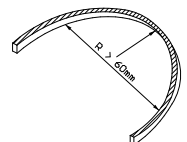

## Main lighting techniques

### Luminous flux, lumen (lm)

Represents the energy of light produced by a light source per unit time.

### Illumination, lux (lx)

Represents the quantity of light produced by a light source onto a surface. 1 lux is equal to 1 lumen per square meter.

### Colour temperature, Kelvin degrees (°K)

Expresses the colour appearance of the light emitted.

### Colour rendering index (CRI)

Indicates the colour rendering of a light. The colour of the light is equal to the colour temperature + colours chromatic efficiency index.

**The shade has been standardised (UNI 12464) in three groups according to the following table:**

Pos.	Range	Indications	References
1	Up to 3300°K	Warm tones (Warm White - <b>WW</b> )	Candlelight
2	From 3300°K to 5300°K	Daylight or neutral light (Natural White - <b>NW</b> )	Sun at midday
3	Up to 5300°K	Cold light (Cold White - <b>CW</b> )	Cloudy sky

### Light sources normally used on a day-to-day basis

Lamp type	Average efficiency	Power generally used	Average life expectancy
Incandescent	13...15 lm/W	25 W	1000 hours
Flourescent	60...80 lm/W	10, 15, 20 W	8000 hours
Halogen	16...20 lm/W	10, 20, 50 W	2000 hours
White Led	50...110 lm/W	2...6 W	50.000...80.000 hours

**Compared to conventional light sources, Led lights offer numerous advantages such as:**

- Small size
- Low heat dissipation
- Long lasting
- Possibility to adjust the brightness and with different tones and colours
- Considerable energy savings, reducing the load on power supply
- Increased safety in potentially explosive atmospheres
- Greater resistance to shocks and vibrations
- Lack of emission of ultraviolet rays and absence of harmful gases

Nowadays Led lights can easily replace other lamps, reducing electric absorption and improving lighting. Moreover, most of them have the great advantage of being able to work with voltages between 10 and 30 volts, so they are not affected by drops or power surges, with the consequent variations in lighting and breakage which occurs with other types of lamps.

### Binding Union preferred luminosity readings

Many companies that produce lamps provide the luminous flux data (Lumen), even though it indicates the brightness at the source and not the perception of the light emitted, which can lose around 40% to 50% through the lenses covering the source.

Binding Union prefers to refer to the Lux, which is the unit that measures the brightness on a given surface at a preset distance from the light source, thus indicating the real perception of brightness. Therefore, by measuring the efficiency of the lamps in Lux, the information provided is more true to life than that of our competitors and facilitates designers who have to establish the quantities and models of the lamps required to illuminate a certain area.

#### Elevator lighting (UNI EN 81-1/2 standards)

#### Recommended light intensity (Lux)

#### BU models

Engine rooms	At least 200 lux at floor level	Mattonella
Pulley rooms	At least 100 lux, on pulleys	Mattonella, Tecla, Sibilla
Elevator shaft	At least 50 lux at a height of 1 m on lift car roof	Tecla
Lift cabin	At least 50 lux, at floor level and on controls. In the event of power failure, the emergency back-up circuit must supply at least 5 lux for a minimum of 3 hours	Punto, Zen, Iris AV Mattonella
Lift entrance	At least 50 lux, at floor level in the proximity of the lift doors	Mattonella

#### Nautical lighting CEI EN 60598-1 standards

#### Recommended light intensity (Lux)

#### BU models

Control lighting	50...100 lux (instrument and electrical panels)	Moda
Exterior lighting	100...150 lux (cockpit)	Mini, Luxboma, Pola, Mignon
	70...100 lux (bridge), 100...150 lux (platforms and fly)	Iris IE, Pola, Mignon
Interior lighting	100...150 lux (salon), 200...250 lux (galley)	Saba, Tubo, Viola, Vanda
	100...150 lux (head)	Mini, Zen, Saba
For reading and chartwork	150...200 lux (chart table)	Mini, Saba, Vanda
Courtesy lights	50...70 lux (stairs, walkways, berths)	Perla, Gemme, Spillo
Technical rooms	70...100 lux (corridors)	Mattonella, Tecla
	100...150 lux (engine rooms)	Samba, Fiamma, Ilogo
	70...100 lux (garage)	Mattonella, Tecla, Atex
Underwater lighting	800...2000 lux	Iris and Iris plus

## A FEW EXAMPLES OF APPLICATIONS

*Pico*



*Luxboma, Touch*



*Sibilla*



*Iris Plus*



*IRIS Antivandal*



*Moda*



*Retailer*



*Promoter*

